

HÜRNER

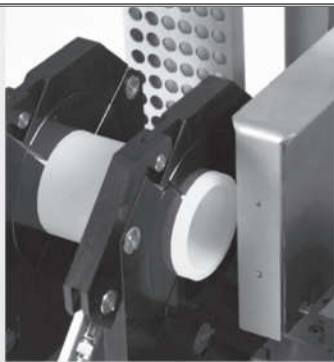

HÜRNER
SCHWEISSTECHNIK

Bedienungsanleitung • User's Manual • Manuel utilisateur

WeldControl EF 250



HÜRNER SCHWEISSTECHNIK GmbH
Nieder-Ohmener Str. 26
35325 Mücke (Atzenhain)

+49 (0)6401 91 27 0
+49 (0)6401 91 27 39
info@huerner.de
<http://www.huerner.de>

HÜRNER
SCHWEISSTECHNIK

Version September 2017

Contents

1	Introduction	5
2	Safety Messages	5
2.1	Reading the User's Manual	5
2.2	Explaining Icons	5
2.3	Operating the Product Safely.....	6
2.4	Owner and Operator Obligations.....	7
2.5	Intended Use	7
2.6	Warranty.....	8
2.7	Transport and Storage	8
2.8	Identifying the Product	8
3	Understanding the Machine	8
3.1	Included Components.....	8
3.2	Control Panel.....	9
3.3	Connectors.....	9
3.4	Technical Specifications	10
3.5	Overview of the Welding Process	11
4	Operation	12
4.1	Configuring the Machine, Entering Welding Parameters.....	12
4.1.1	Setting the Default Configuration of the Machine	14
4.1.2	Understanding the "Settings" Sub-menu	14
4.1.3	Selecting the Display Language	15
4.1.4	Setting the Clock.....	15
4.1.5	Setting the Buzzer Volume.....	15
4.1.6	Understanding the "Recording" Sub-menu.....	15
4.2	Entering Preformatted and User-defined Traceability Data	16
4.2.1	Entering the Welder ID Code	16
4.2.2	Entering or Changing the Commission Number	16
4.2.3	Entering or Changing the Joint Number.....	17
4.2.4	Entering oder Changing Further Data on Component Traceability	17
4.3	Butt Welding in the WeldControl Mode	17
4.3.1	Facing the Pipe Butts	18
4.3.2	Checking Pipe Alignment and Determining Drag Pressure	19
4.3.3	Possibility to Change Welding Parameters.....	19
4.3.4	Setting the Joining Pressure and Starting the Bead Build-up Stage	19
4.3.5	Heating Stage.....	20
4.3.6	Change-over Stage.....	21
4.3.7	Joining and Cooling Stage	21
4.3.8	End of Welding	21
4.4	Fully Manual Butt-welding Process.....	21
4.4.1	Bead Build-up Stage	23
4.4.2	Heating Stage.....	23
4.4.3	Change-over Stage.....	23
4.4.4	Joining and Cooling Stage	23
4.4.5	End of Welding	24
4.5	Performing an Electrofusion Joint.....	24
4.5.1	Connecting the Fitting.....	24
4.5.2	Reading the Fitting Code with a Handheld Scanner	24
4.5.3	Entering Welding Parameters Manually	24
4.5.4	Starting the Welding Process	25
4.5.5	Welding Process	25
4.5.6	End of Welding	25
4.5.7	Cooling Time	25
4.6	Aborted Welding Process	25
4.7	Using ViewWeld to View Welding Reports and Print Tags	27

5	Downloading the Reports	28
5.1	Selecting the File Format and the Welding Process.....	28
5.2	Downloading All Reports	29
5.3	Downloading by Commission Number, Date or Report Range.....	29
5.4	Understanding the Report Download Process	29
5.5	Deleting Data from Memory.....	29
5.6	Keeping Data in Memory	29
6	Service and Repair.....	29
7	Service and Repair Contact.....	30
8	Accessories/Parts for the Product	30
	Appendix	31



The success of a butt-welding jointing operation depends on the proper pressures, times, and temperatures of the welding as given in the welding value tables in the appendix. The correct pressure value depends on the section of the cylinder of the welding machine. Prior to using the tables in the appendix, verify carefully that the section quoted in the technical specifications of this manual is the same as the section given on the name plate affixed to your machine.

1 Introduction

Dear Customer:

Thank you very much for purchasing our product. We are confident that it will bring you success and meet your expectations.

The development, manufacture, and check of the integrated combo welding system **HÜRNER WeldControl EF 250** has been performed with a view to superior operation safety and user-friendliness. The system was manufactured and checked according to state-of-the-art technology and widely recognized safety provisions.

To ensure maximum operation safety, please conform to the appropriate messages in this booklet and the rules for the prevention of accidents.

Thank you.

2 Safety Messages

This User's Manual contains important instructions for the intended and safe operation of the product. Every person who operates the product has to conform to the instructions of this manual.

2.1 Reading the User's Manual

The User's Manual is presented according to sections which explain the different functions of the product. Unmarked paragraphs or sections are valid for both welding modes that the product allows (see Sect. 2.5 and 3.5).

Paragraphs or sections marked by the symbol to the right apply to the jointing mode of welding with eletrofusion fitting only.



Paragraphs or sections marked by the symbol to the right apply to the jointing mode of butt welding with heating element only.

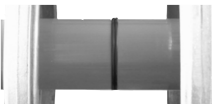

All rights, in particular the right to copy or reproduce (in print or electronic form) and distribute as well as to translate, are reserved and subject to prior written consent.

2.2 Explaining Icons

The following expressions and icons are used in this User's Manual to refer to safety-related issues:



Caution

This icon indicates that non-compliance may result in a hazardous situation that possibly causes bodily injury or material damage.



Important

This icon indicates important messages related to the correct use of the product. Non-compliance may cause problems of operation and damage to the product.



Info

This icon indicates tips and useful information for using the product more efficiently and more economically.

2.3 Operating the Product Safely

For your own safety, comply with the following instructions:

- Protect the power supply cord and the hydraulic pressure hoses or the welding cable from cutting edges. Have an authorized service shop replace damaged cables or hoses immediately.
- The product may be operated and serviced exclusively by authorized staff who were briefed on it.
- The product may be operated only when observed.
- Before operating the product, always check for damaged parts and have them repaired or replaced by an authorized service shop as needed.
- The cover caps of the hydraulic hoses and connectors and the interface ports have to be closed during transport in order to prevent contaminants and humidity from entering the hydraulic and control unit.
- Mains suppliers' wiring regulations, VDE provisions, DIN/CE standards, and applicable national laws have to be respected.
- Without prior authorization by the manufacturer, modifications to the product are unacceptable.



Caution

Parts Under Power

After opening the machine or removing the cover, parts of it are accessible that may be under power. The machine may be opened exclusively by an authorized service shop.



Caution

Pipe Facing Tool

Start the pipe facing tool only after it was inserted into the machine and carry it only by the handle, never by the disk enclosure.

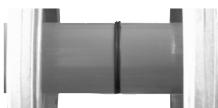

It is unacceptable to remove shavings from the machine while the facing process is in progress. Make sure nobody is present in this danger zone.



Caution

Heating Element

When working with the machine, be extremely cautious while the heating element is used. Since the heating element presents a temperature of more than 200°C during the welding process, it is absolutely indispensable that operators wear suitable protective gloves. Bear in mind that the heating element will remain hot for a while after it was turned off.

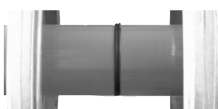

Caution

Electrofusion Fitting

A welding process must never be repeated with the same fitting, since this may cause parts under power to be accessible to the touch.



Caution

Danger of Bruises and Injury

Do not remain in the danger zone while the machine carriage moves apart or closes in, and be sure not to have your arms or legs between the moving and the fixed carriage of the machine.

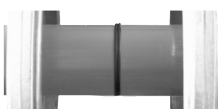

Caution

Acceptable Work Conditions

The work zone has to be clean and has to have proper lighting. It is dangerous to operate while it is raining, in a humid environment, or close to flammable liquids. In regard of this,

acceptable work conditions have to be ensured (tent, heating, etc.).

Before every use of the product, check safety features and possibly existing parts with minor damage for proper function. When working in the EF mode, make sure that the push-on connection terminals work properly, that contact is fully established, and that the contact surfaces are clean. All parts have to be installed correctly and properly conform to all conditions in order for the product to function as intended. Damaged safety features or functional parts should be properly repaired or replaced by an approved service shop.



User's Manual

The User's Manual has to be available at any time on the site where the machine is used. If the User's Manual becomes incomplete or unreadable, replace it without delay. Feel free to contact us for assistance.

2.4 Owner and Operator Obligations

- The product may be operated exclusively by persons who are familiar with the applicable rules, the guidelines for the prevention of accidents, and the User's Manual. The owner/manager shall provide the worker operating the system with the User's Manual and shall make sure that the operator reads and understands it.
- The system may be operated only when observed. Welders must have been briefed properly on the operation of the system or must have participated in a dedicated training. The operating/owning organization engages to check at reasonable intervals if the system is operated by the welders as intended and under proper guidelines of occupational safety.
- The system must be operated only when in proper state of repair and for one of the intended uses. Before welding, the welder is required to make sure that the state of the system is in order.



Important

During transport, the facing tool and the heating element have to be placed into the provided carrying rack at all times.



Important

The dust cap for the data transfer interface port has to cover the port during operation, in order to keep humidity and contaminations away.

2.5 Intended Use

The combo welding system is intended exclusively for joining plastic pipes and fittings according to either the butt-welding process with heating element or the thermoplastic electrofusion process with a heater coil fitting. See Section 3 for an overview of the welding processes enabled by this system.

The notion of intended use also includes:

- Compliance with the instructions in the User's Manual
- Observation of all service and maintenance intervals



Important

All uses other than those mentioned above are not allowed and will cancel any and all liability or warranty by the manufacturer. Unintended use may cause considerable hazards and material damage.

2.6 Warranty

Warranty claims may be raised only if the conditions for warranty given in the General Terms and Conditions of Sale and Delivery obtain.

2.7 Transport and Storage

The box in which the product ships should also be used for storage as a protection against humidity. During transport or storage in the box, the hydraulic tubing should **not be detached or squeezed**. The pipe facing tool and heating element have to be transported in the provided carrying rack.

2.8 Identifying the Product

Every product is identified by a name plate. It shows the model ("Typ"), the serial number ("Maschinennr."), and the manufacturer. The first two digits of the serial number represent the year of manufacture.

Kombi-Schweißsystem	
Typ	WeldControl EF 250
Maschinennr.	14552001
Hürner Schweisstechnik	
Nieder-Ohmener Str. 26	
D - 35325 Mücke	
Tel. +49 6401 9127 0	
CE	

3 Understanding the Machine

This combo welding system for thermoplastic components can be used both as an on-site and as a workshop installation. Its hydraulic and control unit enables connecting both the welding cable to an electrofusion fitting and all lines to heating element, facing tool, and hydraulic cylinders of a butt-welding machine chassis.

Thus, jointing operations pipe-to-pipe, but also for processing tees and elbows are possible using both welding processes. (Butt welding other than pipe-to-pipe requires the modification of the basic machine chassis described in the first paragraphs of Sect. 4.3 and 4.4.) For the butt-welding process, the system enables welding according to two modes, the Manual Mode and the Data Logging/Report Generation mode, or WeldControl Mode for short (see Sect. 3.5).

Whether the system operates according to the butt-welding or electrofusion process, is a matter of which cable is connected to the hydraulic and control unit: electrofusion fitting welding cable or butt-welding heating element control cable.

3.1 Included Components

The product ships in its transport box with the following components:

- Welding cable for connecting an electrofusion fitting
- Adapters for welding cable terminals 4.7 x 4,0 mm, for fittings of manufacturers Friatec, GF, agru, Wavin, Euro-Standard
- RFID card with access code of configuration menu
- Tools
- Machine chassis ("basic machine") to secure the parts to be welded, for butt welding, as the following two
- Electrical heating element with anti-stick coating
- Electrical facing tool
- Carrying and storage rack for heating element and facing tool
- Hydraulic and control unit with control panel, for both welding processes
- Reducer inserts for clamps of machine chassis for the following nominal pipe sizes: O.D. 75, 90, 110, 125, 140, 160, 180, 200, 225 mm

3.2 Control Panel

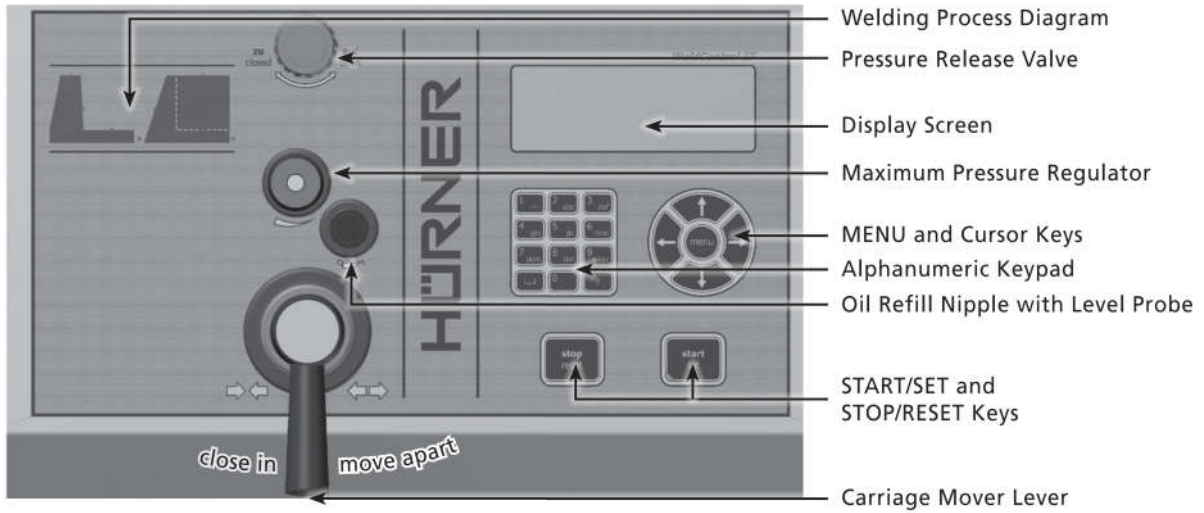

3.3 Connectors

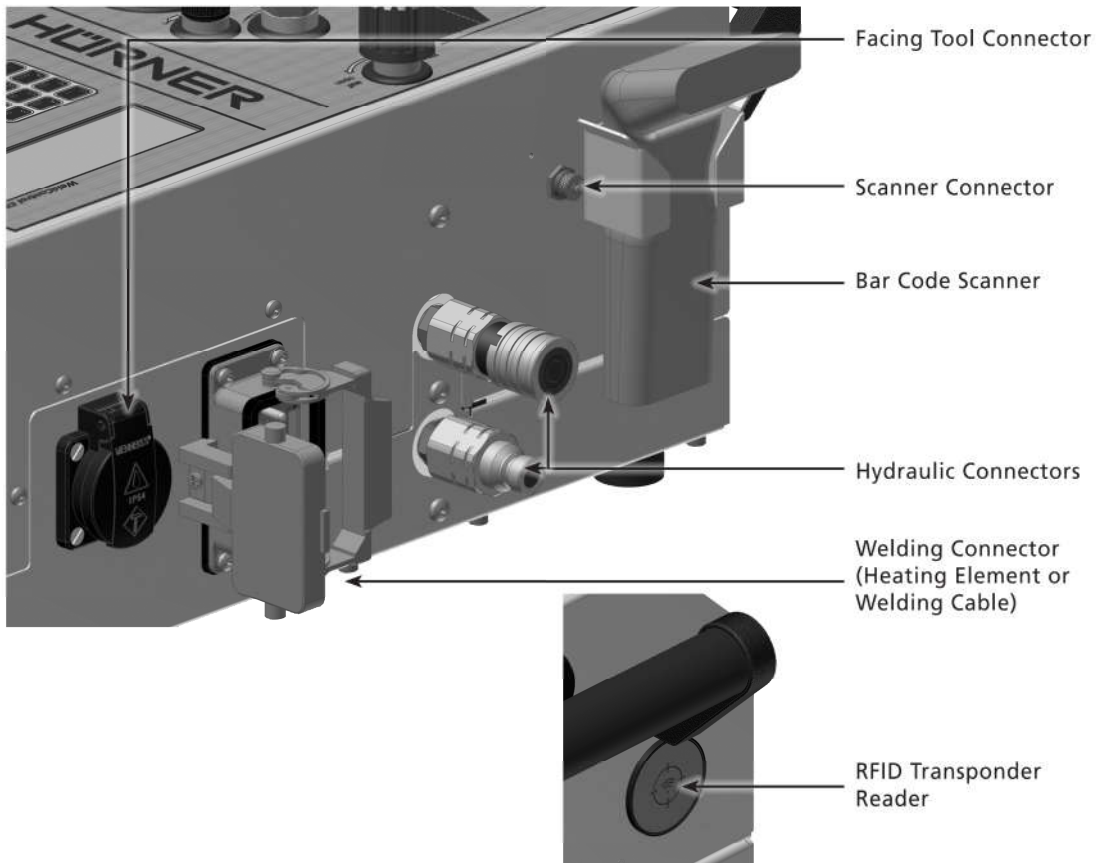

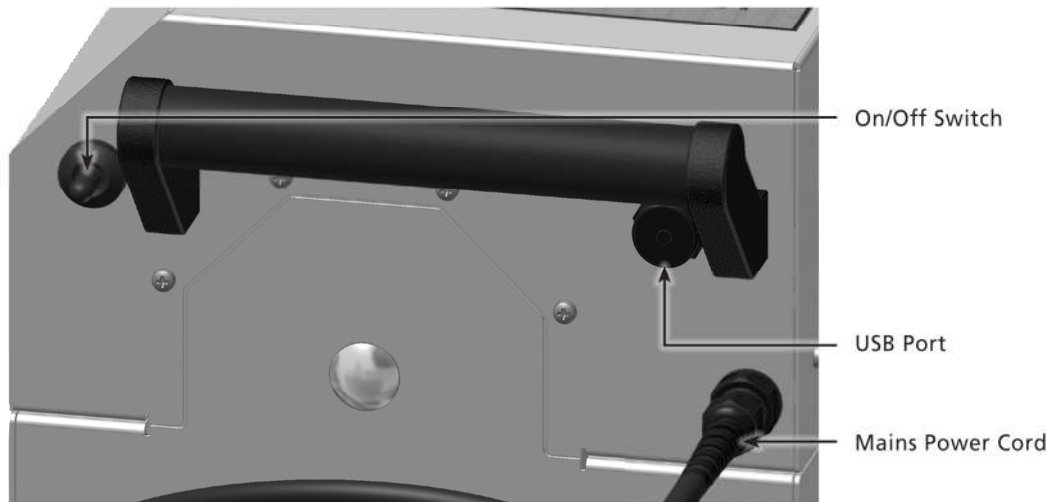

3.4 Technical Specifications

HÜRNER WeldControl EF 250	
Power Specifications	
Voltage	230 V
Frequency	50 / 60 Hz
Rated Power in Electrofusion	2800 VA, 80 % duty cy.
Total Rated Power in Butt Welding	3.65 kW
Heating Element	2.00 kW
Facing Tool	1.05 kW
Hydraulic & Control Unit	0.60 kW
Primary Current in Electrofusion	16 A
Secondary Current in Electrofusion	max. 110 A
Output Voltage in Electrofusion	8 V - 48 V
Hydraulic Specifications	
Operating Pressure max.	160 bar
Cylinder	5.10 cm ²
Hydraulic Oil	HF-E 15
Operating Range	75 through 250 mm
Ambient Temperature Range	-20°C à +60°C (-4°F thru +140°F)
Ingress Protection	IP54
Memory for Welding Reports	10,000 reports
Data Interface Port	USB v 2.0 (480 mbit/s) (see also data at the beginning of Sect. 5)
Dimensions	
Basic Machine Chassis	960 x 470 x 470 mm
Facing Tool	440 x 450 x 380 mm
Heating Element	490 x 470 x 50 mm
Hydraulic & Control Unit	480 x 310 x 300 mm
Carrying and Storage Rack	380 x 340 x 370 mm
Weights	
Basic Machine Chassis	54 kg
Facing Tool	15 kg
Heating Element	8 kg
Hydraulic & Control Unit	28 kg
Carrying and Storage Rack	9 kg
Transport Box	37 kg
All Reducer Inserts	58 kg

3.5 Overview of the Welding Process

By plugging either the welding cable to an electrofusion fitting or the control cable of the heating element for butt welding into the appropriate connector, the welder decides which welding process will be run. The welding control program supports, with both possible processes, the extended data encoding specifications under the ISO 12176 standard, e.g., pipe and fitting traceability codes. To use this capability, the desired data have to be enabled in the configuration menu, at "Recording" (see Sect. 4.1).

With both possible processes, all data that are relevant for the joint or for component traceability are saved to the internal memory and can be sent to a USB stick.

Using the **electrofusion process** allows welding electrofusion fittings that feature a bar code. Every fitting is provided with a tag with one or two bar codes on it. The structure of this code is internationally standardized. The first code, encoding the data on proper welding, complies with ISO 13950, the second code, if present, encoding the component traceability data, complies with ISO 12176.



The welding parameters can also be entered manually. The welding system is microprocessor-controlled and:-

- controls and monitors the welding process in a fully automated way, when the welder starts it after component preparation,
- determines welding duration depending on ambient temperature,
- shows all information on the display in plain text.

In the **manual mode of the butt-welding process**, the machine performs a classic, manual butt-welding operation. It monitors the temperature of the heating element, taking the desired nominal temperature that can be set using the ↑ and ↓ cursor keys, into account, and readjusts it as needed.



In the **WeldControl mode of the butt-welding process**, the machine walks the welder through the welding process, monitors all relevant parameters, and allows entering traceability data for the welded components on intuitive menu screens. Parameters of the welding operation, component traceability data, and possible errors are recorded and saved to memory and can be transferred via one of two USB interface ports to a USB stick, a USB-compatible printer, or a PC with the management and database application DataWork.

The welder performs the butt-welding process in the following manner:

- Pipes are clamped into the frame.
If pipes with an outside diameter smaller than the maximum dimension of the machine are welded, select the reducer set needed. The 8 individual inserts of the set that matches the outside diameter of the pipe to be welded have to be attached to the clamps of the machine chassis using the provided bolts.
- In the **manual mode**, applicable welding times and pressures are looked up in the overview tables in the appendix.
- In the **WeldControl mode**, the mandatory and the optional component traceability data are entered in the menus on the screen.

- Pipe butts are worked using the pipe facing tool.
- Pipe alignment is checked.
- The drag pressure, i.e. the minimum pressure to set the carriage in motion and “drag” it along, is recorded at the machine.
- The pressures relevant to the welding operation are set.
- The heating element is inserted after cleaning it and checking its temperature.
- The welding process proper is performed (see section 4), and the operator waits for the jointed pipes to cool down.
- After the cooling time is over, pressure can be shut off from the pipes (in the manual mode by the welder, in the WeldControl mode automatically by the machine) and the joint can be taken out of the chassis.

4 Operation



To operate the welding system, be sure that it is set on a proper, level surface and that power supply protection is 16 A (slow blow).

Important



Before the control unit is turned on, check the oil level of the hydraulic and control unit and top up with HF-E 15 hydraulic oil as needed.

Important



The surfaces of the heating element have to be free of grease and clean, or they have to be cleaned.

Important

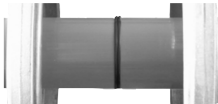

Make sure all connectors are tight in their sockets and note that operation on a worksite is only acceptable if the power supply has earth-leakage circuit breakers.

Important

After connecting the power supply cord to the mains power supply or a generator, turn the machine on at the On/Off switch.



Caution

It has to be ensured that the voltage of the power source the machine is connected to corresponds to the rated voltage of the machine. Also the following has to be respected when using extension cables:

For 230 V power: wire section 1.5 mm² = max. 20 m long
wire section 2.5 mm² = max. 75 m long
wire section 4.0 mm² = max. 100 m long

4.1 Configuring the Machine, Entering Welding Parameters

After the machine was switched on, Display 1 shows on the screen.

The machine will then automatically start the auto-test process to check the sensors and the system clock and to determine the number of free welding reports. This test can be bypassed by holding down the STOP/RESET key when Display 1 is showing.

```
*****
*           HUERNER           *
*WeldControl EF 2.0*
*****
```

Display 1



Caution

If during the auto-test an error is detected, a “System Error” message shows on the display. When this happens, the welding unit has to be disconnected immediately from the power supply and the fitting or heating element/facing tool, and it has to be returned to the manufacturer for repair.

```
Please connect
welding cable/
heating element
```

Display 2

Subsequent to a successful auto-test or after the test was bypassed, the machine first shows overview screens on

the selected kind of machine and welding standard, then Display 2.

After one of the cables was connected to its appropriate connector at the hydraulic and control unit, Display 3 shows the the data of the next welding, including time of day, date, report number, and joint number, along with, in the second-to-last line, the actual input voltage and—if the cable of the heating element for butt welding is connected—the actual and nominal heating element temperature before and after the slash. The last line shows no report number, but “No contact” if the welding cable to an electrofusion fitting is connected to the hydraulic and control unit, but not to the fitting to be worked yet.

Next welding	
15:44:52	29.05.12
235V	135C/220C
Rep. No.	00072/00002

Display 3

From Display 2 and Display 3, it is possible to access the Configuration Menu in which the default behavior of the welding machine can be configured. To access it, press the MENU key and then, on the following enter-code screen, type the access code using the alphanumeric keypad or hold the transponder card in front of the RFID reader. When the menu is accessed from Display 2, all parameter settings can be configured; when it is from Display 3, only those that make sense for the currently started welding process are available.

CODE : 415311



The alphanumeric keypad is designed and works like the keypad of a traditional mobile phone. If an input is numerical, the keypress generates the number found on the respective key. For an alphanumeric input, all characters found on a key can be generated by pressing that key repeatedly. As soon as the desired character can be read on the screen, wait a little longer until you press the next key to use the displayed character.

Settings	-M-
>Reporting	-M-
Sensor Parameter	-M-
Machine Data	-M-

Display 4

Pressing the \uparrow and \downarrow cursor keys in the menu that appears (Display 4), you can select a menu option, then access the selected sub-menu by pressing the MENU key again.

In the Machine Data sub-menu, the type of machine (its designation and its cylinder section) to which the hydraulic, control, and data logging/report generation unit is connected, has to be defined (see the arrow symbol in Display 5). This definition is preset ex works and needs changing only when, exceptionally, the control unit is connected to a different machine. To change it, select the proper machine type by pressing the \uparrow or \downarrow cursor keys and confirm by pressing the START/SET key.

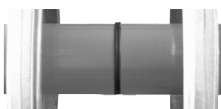

HST 200	3.16
>HST 250	5.10
HST 315	5.89
HST 355	6.60

Display 5



Important

If the wrong machine is selected in this menu, all pressure computations that the machine makes when welding in the WeldControl mode, will be wrong! Changing to another machine requires consultation with the manufacturer or an authorized service shop, as a sensor calibration is then also recommended. This step requires proper authorization

As an addition to the preinstalled machines, user-defined machine types can be set as needed at the unused menu entries (a designation for the machine and its cylinder section have to be entered).

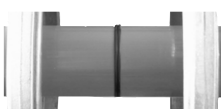

The Sensor Parameters sub-menu, used to calibrate the pressure and the temperature sensors, should be accessed by authorized staff only and is, therefore, protected by another access code disclosed only to such personnel as is allowed to manage these settings.

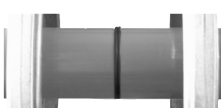

4.1.1 Setting the Default Configuration of the Machine

In the sub-menus of the Configuration Menu, at "Settings," the parameters related to the welding unit itself and its operation can be set. At "Recording," the traceability data that have to or need not be recorded and written into the reports can be enabled or disabled. The desired sub-menu is selected using the \uparrow and \downarrow arrow keys. Then to access that sub-menu, press the MENU key.

In both parts of the configuration menu, use the \uparrow and \downarrow arrow keys to select the desired set-up option. Use the \Rightarrow arrow key to toggle between "on" and "off" for that set-up option.

If a "M" is shown next to a set-up option, this indicates that a sub-menu is accessible here by pressing the MENU key.



Important

On both menu levels (Configuration Menu and its respective sub-menus), press the START/SET key to save the settings to memory or press the STOP/RESET key to return to the previous menu level without saving possible changes.

4.1.2 Understanding the "Settings" Sub-menu

"Check Code Expiry on" means that the welder identification code has to be current and not expired (default period of validity 2 years from code issuance), or the welding operation cannot be started, "off," that the validity of the code is not checked at all.

"Memory Control on" means that when the system memory is full of reports, the unit will be blocked until the reports are printed or downloaded, "off," that it works but that the oldest report will be overwritten.

"Automode on" means that in butt-welding operations the Automode feature for the easy management of the welding process (see Sect. 4.3.4) can be used, "off," that the feature is not available.

"Manual Input on" means that the manual input of welding parameters or computed parameters is possible, "off," that the manual input is not allowed.

"Check Ambient Temperature on" means that the outside temperature is measured before welding, "off," that it not; if the temperature is below 0°C (32°F), welding should be performed only after taking appropriate precautions (heating, tent, for instance).

"Welder Code Options – M –" means that by pressing the MENU key, the user can access a sub-menu that allows determining when the welder code, if it is enabled at "Recording," has to be entered: always, i. e. before every single welding operation, only before the first welding operation after switching the unit on or only after the first welding operation of a new day/date.

"Language – M –" means that by pressing the MENU key, the user can access a sub-menu for selecting the display and report language (see Sect. 4.1.3).

"Date/Time – M –" means that by pressing the MENU key, the user can access a sub-menu for setting the clock (see Sect. 4.1.4).

"Buzzer Volume – M –" means that by pressing the MENU key, the user can access a sub-menu for setting the volume of the status buzzer (see Sect. 4.1.5).

"Temperature Unit – M –" means that by pressing the MENU key, the user can access a sub-menu for selecting centigrade or Fahrenheit as the unit for the temperature.

"Pressure Unit – M –" means that by pressing the MENU key, the user can access a sub-menu for selecting bars or pounds per square inch (psi) as the unit for the pressure.

"Length Unit – M –" means that by pressing the MENU key, the user

```
***   SETTINGS   ***
Check Code Exp. Off
Memory Control  On
>Automode      On
```

Display 6

can access a sub-menu for selecting millimeters or inches as the unit for the length.

“Inventory Number – M – ” means that by pressing the MENU key, the user can access a sub-menu for entering the number under which the unit is inventorized with the operating company.

“Number of Tags – M – ” means that by pressing the MENU key, the user can access a sub-menu for entering the number of tags that are printed automatically after welding with the optional label tag printer if such a printer is connected.

“Standard – M – ” means that by pressing the MENU key, the user can access a sub-menu for selecting the standard (guideline, normative scheme) applicable to the welding operation.

4.1.3 Selecting the Display Language

When the “Select Language” sub-menu was selected, the screen changes and the display reproduced in Display 7 appears.

```
***** LANGUAGE *****  
>Deutsch  
English  
Francais
```

Display 7

Use the cursor keys \uparrow and \downarrow to select one of the options, “Deutsch,” “English,” and “Français” and confirm by pressing the START/SET key.

4.1.4 Setting the Clock

When the “Set Clock” sub-menu was selected, the screen changes and the display reproduced in Display 8 appears.

```
Date/Time  
  
21.06.13      14:28
```

Display 8

The time of day and the date can be set using the keypad. The portions “Hour,” “Minute,” “Day,” “Month,” and “Year” are set separately. Press the START/SET key to confirm your settings.

4.1.5 Setting the Buzzer Volume

When the “Set Volume” sub-menu was selected, the screen changes and the display reproduced in Display 9 appears. The buzzer can also be heard. Turn the buzzer volume up or down to the desired value using the \leftarrow , \rightarrow arrow keys (from 0 to 100) and confirm your setting by pressing the START/SET key.

```
Buzzer Volume  
< -----20----- >
```

Display 9

4.1.6 Understanding the “Recording” Sub-menu

“Welder Code on” means that the welder identification code has to be entered as set with “Welder Code Options,” “off,” that this is impossible.

“Commission Number on” means that the commission number (job number) will have to be entered or confirmed before every new welding, “off” that the user is not prompted to enter it.

“Joint Number on” means that the unit assigns an automatically incremented joint number to every welding operation belonging to a commission already known, and displays this number on the screen next to the report number, “off” that no joint numbers will be assigned at all.

“Additional Data on” means that the additional data will have to be entered or confirmed before every new welding, “off” that the user is not prompted to enter them.

“Fitting Code on” means that the second, so-called traceability code of the electrofusion fitting has to be entered before every welding, “off,” that this is not possible.

“Pipe Codes on” means that the codes of both pipes/components (ISO-compliant welding and traceability codes) have to be entered before every welding, “off,” that this is not possible.

“Pipe Length on” means that the length of both pipes/components has to be entered before every welding, “off,” that this is not possible.

```
** CONFIGURATION **  
>Welder Code      On  
Commission No.    On  
Joint No.         Off
```

Display 10

- “Weather Conditions on” means that the weather has to be selected in a list before every welding, “off,” that this is not possible.
- “Installing Company on” means that the company that performs the installation work has to be entered before every welding, “off,” that this is not possible.
- “Print Tags – M – ” means that by pressing the MENU key, the user can access a sub-menu for starting to print (a) label(s) with reference to a given welding operation, with the optional label tag printer.
- “Angle – M – ” means that by pressing the MENU key, the user can access a sub-menu for entering the angle, in degrees, between the two components that are going to be welded.



All data that are available in the chip of a transponder card can be entered by placing the card in front of the card reader. If they are encoded in a bar code, they can be read using the handheld scanner.

4.2 Entering Preformatted and User-defined Traceability Data

When the system is used for the electrofusion process or the butt-welding process in the WeldControl mode, all traceability data enabled in the configuration menu at “Recording” (see Sect. 4.1.6) have to be entered before the welding process. The welding unit prompts the user to enter them before the welding process proper. Depending on what data is entered, either its repeated input is mandatory (e.g., the welder ID code; see Sect. 4.1.2) or previously entered data can be changed and confirmed or confirmed without changes (e.g. the commission number; see Sect. 4.2.2).

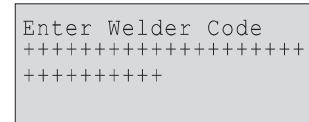

Display 11

4.2.1 Entering the Welder ID Code

When the welding is started by pressing the START/SET key while Display 3 is showing, first the input of the welder identification code is requested, if it is enabled in the Configuration Menu (see Display 11). The code has to be an ISO-compliant code. It can be entered either using the alphanumeric keypad (see the first info in Sect. 4.1) and confirming the input by pressing the START/SET key, or by reading a RFID transponder card or scanning it from a bar code with the optional handheld scanner.

When the code was properly scanned or entered, this is confirmed by an audible signal.

4.2.2 Entering or Changing the Commission Number

From Display 3 or after the welder identification code was entered, the machine requests the input of the job number, or commission number, of a maximum 32 characters if it was enabled in the Configuration Menu. If a commission number exists already in memory, this one is proposed. You can either confirm it by pressing START/SET or change it using the alphanumeric keypad (see the first info in Sect. 4.1) or reading it with the optional scanner or from a RFID card and then confirm the new number by pressing the START/SET key.



Display 12

It is possible to select a previously saved commission number instead of the one shown on the screen by pressing the ⇐ and ⇒ cursor keys simultaneously. This causes the screen to show in which you can scroll through the commission numbers in memory using the ⇐ and ⇒ keys, to select a number and then confirm it by the START/SET key. This number will be used for the next welding. To quit the scroll mode without selecting a commission, press the STOP/RESET key.

4.2.3 Entering or Changing the Joint Number

From Display 3 or after the commission number was entered, the machine requests the input of the welding number, or joint number, if it was enabled in the Configuration Menu.

The joint number, or welding number, is in correlation with the job/commission number. This means that it increments by 1 for every welding operation performed in the scope of the current commission (identified previously by entering the appropriate job number). In the example in Display 3, the next welding operation will be saved to welding report number 72 while the joint itself is joint number 2 of the current job/commission.



The first joint of a commission for which no joint has been saved to memory so far, always receives no. 1. If the memory already holds joints for a commission, the machine finds the highest number of the joints existing for that commission and uses this number plus 1. The user is shown the number thus found on the screen and can apply or change it. If the user changes the joint number, it is his responsibility to make sure that no number is assigned twice in one commission. If a joint number appears twice in a commission, this will not affect the welding process and the logging of its data in any way. However, in that commission two joints will not be distinguished by a unique number.

If user inputs leave some joint numbers unused (for instance, for a given commission no. 1, 2, 3, 5, 6, 9), the gaps do not get filled, and the automatically found number proposed for the next welding operation will still be the highest existing number plus 1 (that is, 10 in this example).

The joint number can also be entered after simultaneously pressing the cursor keys \leftarrow and \rightarrow when Display 3 is showing on the screen.

4.2.4 Entering oder Changing Further Data on Component Traceability

In the same way as welder identification code, commission and welding number, other data relating to the components can be entered if they were enabled in the Configuration Menu. They are requested in the following order (not all of them in both welding processes that can be used): length of the 1st pipe, code of the 1st pipe, length of the 2nd pipe, code of the 2nd pipe, code of the fitting, weather conditions, additional data (as defined by the user).

```
Weather
>sunny
clear
rain
```

Display 13



If pipe codes for the two pipes are entered and if those pipe codes state different sizes and/or Standard Dimension Ratios (SDR) for the pipes, then a code error is triggered since these welding parameters must be identical for both pipes.

All data can be entered by using alphanumeric keys and confirming them by pressing the START/SET key or can be scanned from a bar code or a RFID card, if available, with the scanner or transponder reader. One exception is the weather (see Display 13). This option is presented as a list in which the applicable conditions can be selected by pressing \uparrow or \downarrow and confirmed by pressing the START/SET key.

4.3 Butt Welding in the WeldControl Mode

The welding process can be performed fully manually (Manual Mode) or with the support of the hydraulic, control, and data logging/report generation unit (WeldControl Mode), which displays all steps



needed during welding on the screen to the welder's attention or has him confirm them, and which makes a report of the welding operation. No welding report is generated when the welding is fully manual.

Below, this booklet first presents the welding process in the WeldControl Mode. How welding is performed in the Manual Mode is explained in Section 4.4.



If the machine is set to Manual Mode (fully manual welding process without data logging/report generation), the operator can switch it to WeldControl Mode by pressing the ⇐ and ⇒ arrow keys simultaneously.

To start welding, clamp the pipes into the machine chassis. Use the appropriate reducer inserts if the component size is smaller than the basic machine chassis. When the fourth clamp of the machine is removed, tees and elbows can be processed. Then, to launch the welding process, press the START/SET key.

After all traceability data enabled in the configuration menu were entered, the parameters of the pipes to be welded have to be entered. If pipe parameters of an earlier welding are available and no code error was detected, all welding parameters of the previous welding are proposed and can be confirmed in one go (see Display 16).

From this display, it is possible to change the pipe parameters by pressing the STOP/RESET key. Then the first thing is to select the pipe material in a list; use the ↑ and ↓ cursor keys and confirm by pressing the START/SET key (see Display 14). Then the alphanumeric keypad (see the first info in Sect. 4.1) allows entering the diameter and the wall thickness, both confirmed by the START/SET key (see Display 15). Instead of the wall thickness, you may want to enter the Standard Dimension Ratio (SDR); then display this input line instead of the wall thickness line by pressing the ⇐ and ⇒ simultaneously and enter the SDR value. The machine then displays the whole set of parameters as an overview. In case there are errors, it is possible either to enter all data once more by pressing the STOP/RESET key, or to return to the previous step by pressing ↑ and correct the data one at a time.

If pipe codes were entered previously in the traceability data for the joint, the machine automatically presents the welding parameters contained in the pipe codes for confirmation.

4.3.1 Facing the Pipe Butts

To ensure that the pipe butts are level, insert the pipe facing tool between the machine carriages and turn it on. Using the carriage mover lever on the hydraulic unit, have the movable carriage close in toward the center in order to bring the pipes into contact with the facing tool. Use the pressure regulator to adjust the pressure manually, if needed, while the facing tool is trimming the pipes.



The farther the carriage mover lever is pushed to the left, the faster the carriage closes in and the faster pressure increases. The farther it is pushed to the right, the faster the carriage of the machine moves apart, and the faster pressure decreases.

Pipe facing should continue until shaving forms a continuous blade that rolls twice or three times around the pipe ends, so the butts are

```
SELECT PIPE MATERIAL
>PE80
PE100
PP
```

Display 14

```
ENTER PIPE DIMENSION

Pipe Diameter:0250mm
Wallthickness:22.7mm
```

Display 15

```
Pipe Material: PE80
Pipe Diameter:0250mm
Wallthickness:22.7mm
RESET SDR11.0 SET
```

Display 16

```
Face Pipe Ends

230°C ACT. 0.5bar
```

Display 17

level. Facing is stopped by moving the carriage apart with the carriage mover lever.

If you discover after the facing process that the butts are still not level, start over, insert the facing tool and repeat the process. When facing is properly done, pipe alignment has to be checked.

The facing process is shown on the display screen (see Display 17). The START/SET key has to be pressed by the welder to confirm that facing is properly finished.

4.3.2 Checking Pipe Alignment and Determining Drag Pressure

When the pipes are properly faced, close in the movable carriage completely to check whether a potential vertical and horizontal pipe misalignment is within the tolerance allowed by the applicable welding standard. The maximum acceptable gap between them is displayed (see Display 18). If pipe alignment is in order, the welding proper can start. If the misalignment is outside tolerance, the pipes must be readjusted in the clamps and, if needed, facing has to be repeated.

When pipe alignment is appropriate, move the carriage apart using the carriage mover lever; make sure the movable carriage is as far apart as possible before continuing. Turn the maximum pressure regulator counter-clockwise as far as it will go to have zero pressure in the hydraulic circuit. Then set the carriage mover lever to its close-in position while simultaneously turning the maximum pressure regulator gradually clockwise. Watch the display closely to observe at which pressure level the carriage is "dragged" to start moving.

The START/SET key has to be pressed when the carriage starts moving, in order to save the drag pressure applicable to this welding to memory.



Important

The exact drag pressure depends on various conditions (pipe size and material, position of the machine, etc.) and has to be determined for every welding individually.

4.3.3 Possibility to Change Welding Parameters

Subsequent to setting the drag pressure, Display 20 shows on the screen, provided that manual data input is enabled in the Reporting sub-menu of the Configuration Menu.

In both screens enabling manual input of welding parameters (Displays 20 and 21), the ← and → cursor keys allow moving on from digit to digit and from value to value. The selected digit of a parameter value is changed using the ↑ and ↓ and the alphanumeric keys. The START/SET key serves to confirm the inputs. By pressing the START/SET key, you also make the control unit go on to the next screen.



Info

The parameters set manually are kept in memory when the machine is turned off. Only the pressure values are computed individually for every welding process. If the pipe parameters change, **all** parameters have to be set once again. The machine recognizes the change of pipe parameters and brings the operator directly to the menu that allows changing them.

4.3.4 Setting the Joining Pressure and Starting the Bead Build-up Stage

After butt facing and pipe alignment check, the welding process proper starts by setting the joining pressure (i.e., the maximum pressure that

```
Check Pipe Alignment
Max. Gap      :2.5mm
```

Display 18

```
Set Drag Pressure

230°C ACT.   3.5bar
```

Display 19

```
Buildup pr.:030.5bar
Heatsoakpr.:010.5bar
Heatsoaking:0120 s
Change-over:0005 s
```

Display 20

```
Cool. time :900 s
Press. ramp:010 s
Plate temp.:223 °C
```

Display 21

will be reached during the process, in the bead build-up stage and at the end of the joining stage). This is done by pushing the mover lever to its close-in position and setting the maximum pressure regulator to the level to be kept during bead build-up and joining/cooling. The actual pressure shows (see Display 22) and the control software moves on to the next step as soon as the pressure is within tolerance.

```
Set Joining Pressure
230°C NOM. 16.5bar
229°C ACT.  3.5bar
```

Display 22

The display also shows the nominal joining pressure applicable to this welding. After setting the joining pressure, move apart the carriage of the machine.



The so-called automode is a tool for monitoring the duration of the bead build-up stage and moving on automatically from the bead build-up to the heating stage by decreasing the applied pressure. However, this requires that the automode was enabled in the Configuration Menu. Then, with enabled automode, Display 23 is shown. Then, to use that bead build-up time saved at the last welding operation, press START/SET. Pressing STOP/RESET will cancel the automode for bead build-up. If the bead build-up is automode-managed, the build-up time is displayed as a countdown, and from 10 sec prior to decreasing the pressure, the audible signal can be heard.

```
**** AUTOMODE ****
Use last bead
build-up time?
RESET          SET
```

Display 23

At the start of the bead build-up stage, place the heating element between the pipe butts. The display tells you so. If the heating element is not sufficiently hot at this point, an information message on the screen asks you to wait a little longer.

Then close in the movable carriage by pushing the carriage mover lever and wait for the weld bead to reach the required height or width, depending on the used welding standard. Observing the bead is also highly recommended in the automode, even though the bead height is not indicated on the screen during an automode-managed bead build-up stage.

```
Put in heat. plate
222°C NOM. 16.5bar
221°C ACT.  0.5bar
```

Display 24

4.3.5 Heating Stage

After the bead build-up stage (1st LED in the welding diagram on the control unit) was completed, pressure must be decreased (2nd LED in the diagram). The decreased pressure will then be applied for the entire duration of the heating stage (3rd LED in the diagram), in which the pipe butts continue to soak heat from the plate.

```
Bead Height      :2.0mm
Bead Build Time:68 s
230°C NOM. 16.5bar
229°C ACT. 12.5bar
```

Display 25

When the bead build-up stage is not automode-managed, the pressure is decreased either with the manual pressure release valve or with the START/SET key, and the decrease has to be observed on the display. When the START/SET key is used, the hydraulic and control unit keeps the heating pressure below the required maximum throughout the heating stage by re-opening the release valve as needed if the pressure rises. If the welder uses the pressure release valve, this automatic control is **not** available. In this case, it is under the operator's responsibility to compensate for potential pressure fluctuations.

The machine also moves on to the heating stage if the welder decreases the pressure to a level below the heat-soaking maximum before the countdown of the bead build-up stage is completely over—which may happen if the bead is o.k. earlier than expected. However, such a pressure decrease has to be quick. In these cases, the bead build-up time shortened by the early decrease is saved to memory as the build-up time for this welding and will be used as a reference for possible automode-managed build-up stages at a later time.

```
HEAT SOAK PHASE
Heat Soak Time :148s
230°C MAX  5.0bar
229°C ACT.  3.5bar
```

Display 26



Important

Full contact has to be continuously established between the heating plate and the bead, even with lower pressure. While heating, if contact between them is lost somewhere along the circumference, welding has to be aborted and repeated. If the control unit detects an error (such as insufficient pressure not readjusted by the welder or excessive heating time), it also aborts welding and displays an error message.

4.3.6 Change-over Stage



Info

An audible signal indicates the imminent change-over during the last 10 seconds of the heat-soaking stage.

At the end of the heating stage, push the mover lever on the hydraulic unit to its move-apart position in order to move the carriage apart. Then remove the heating plate from in-between the pipes.

In the change-over stage, too, all relevant parameters are shown on the screen.

The change-over has to be followed immediately by the joining stage. The change-over time given on the display must not be exceeded. If it is, the welding is aborted automatically and an error is displayed.

4.3.7 Joining and Cooling Stage

Set the carriage mover lever to its close-in position again in order to move the pipe butts in on each other and build the joining pressure. Watch the value on the screen. Building the joining pressure must correspond to a linear increase, as predicted by the nominal values on the screen. The 5th LED of the diagram on the hydraulic unit flashes.

```
Remove plate
Change-over : 8 s
230°C MAX 5.0bar
229°C ACT. 3.5bar
```

Display 27

Once the joining pressure is reached and has stabilized, the pressure will be kept at this level until the end of the joining/cooling stage (6th LED in the diagram). In this stage, the new joint already starts cooling down.

```
Build Joining Press.
230°C NOM. 16.5bar
229°C ACT. 14.5bar
```

Display 28



Important

Right after the end of the linear pressure ramp, at the very beginning of the cooling, pressure may drop slightly for technical reasons. The welder has to compensate for this drop immediately by pushing the carriage mover lever. In this case, the first line of Display 28 reads, "Keep the pressure."

Depending on the welding standard used or on information provided by the pipe or fitting manufacturer, a cool-on time may be required during which the new joint must not be exposed to external forces. This, however, is not monitored by the hydraulic, control, and data logging unit, for which the welding is considered finished when the 7th LED is lit.

```
COOLING PHASE
Cooling time :1234s
230°C NOM. 16.5bar
229°C ACT. 16.5bar
```

Display 29

4.3.8 End of Welding

The welding is finished at the end of the successful joining and cooling stage. The machine releases the pressure on the pipes automatically.

4.4 Fully Manual Butt-welding Process



Info

When you want to weld fully manually, the machine has to be switched to Manual Mode. To do so, press the ⇐ and ⇒ arrow keys simultaneously while "Next Welding" is showing on the screen. In the manual mode, the display screen looks like what Display 31 shows.

```
COOLING PHASE
Cooling time over
229°C ACT. 0.0bar
```

Display 30

In a fully manual welding process, pipe facing, pipe alignment check, determination of the pressure to “drag” the carriage along and of the joining pressure (i.e., the maximum pressure of the welding, reached during bead build-up and joining) have to be performed in the exact same way as in the WeldControl Mode (see the relevant sub-sections of Section 4.3). The only difference is that the display does not provide any hints as to what to do. It just works as a digital gauge indicating the actual pressure applied to the pipes (see Display 31). It also shows the nominal temperature the welder has to set and the actual temperature of the heating element, and it monitors and controls the temperature throughout the process. The parameters for proper welding have to be looked up in the welding value tables in the appendix.



*** MANUAL MODE ***	
220°C	NOM. ---.bar
219°C	ACT. 016.0bar

Display 31



The farther the carriage mover lever is pushed to the left, the faster the carriage closes in and the faster pressure increases. The farther it is pushed to the right, the faster the carriage of the machine moves apart, and the faster pressure decreases.

The nominal temperature, at which the hydraulic and control unit should keep the heating element, can be changed using the \uparrow and \downarrow cursor keys. After such a change, the display shows the actual temperature changing slowly to the new nominal temperature.



Important

The welder must wait for the display to show the new nominal temperature before using the machine!

The welding proper has the four stages in the diagram below that are explained in the following sections. It is under the welder’s responsibility to verify the correct welding pressures and times.

Before the welding process starts, the drag pressure has to be determined with care. Move the movable carriage apart, turn the pressure regulator counter-clockwise as far as it will go, then bring to mover lever to the close-in position and gradually turn the pressure regulator clockwise. Watch the display and note the pressure that “drags” the carriage sufficiently to set it in motion. This is the drag pressure P_t for this welding.



Important

The exact drag pressure depends on various conditions (pipe size and material, position/altitude of the machine, etc.) and has to be determined for every welding individually. The value P_t is needed to compute the bead build-up, the heating, and the joining pressures needed for jointing (stages t_1 , t_2 , and t_5 in the welding diagram respectively).

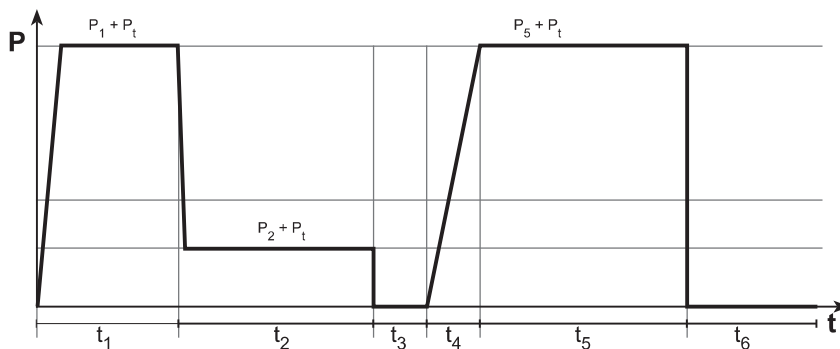

4.4.1 Bead Build-up Stage

Use the welding value tables in the Appendix to look up the joining pressure (maximum pressure to be applied during bead build-up and joining) appropriate for your situation. Then set the maximum pressure regulator to the appropriate pressure while observing the actual pressure displayed on the screen, and move apart the carriage of the machine. Insert the heating element (heating plate), move the carriage in on the plate and press the pipe butts to the plate at a pressure of $P_1 + P_t$ for the bead build-up duration given in the welding value tables in the Appendix (t_1 in the diagram).

4.4.2 Heating Stage

After the bead build-up stage (t_1 in the diagram) was completed, the pressure must be decreased to below or equal to the level of $P_2 + P_t$. The decreased pressure will then be applied for the entire duration of the heating stage (t_2 in the diagram), in which the pipe butts continue to soak heat from the plate. Use the welding value tables in the Appendix to determine the heat-soaking time (t_2) and the heat-soaking pressure ($P_2 + P_t$) applicable to your welding situation.



Info

In the Manual Mode and in the WeldControl Modes, two ways to reduce the applied pressure are available. Either open the pressure release valve or press the START/SET key. Pressing the START/SET key reduces the pressure only as long as you hold the key down.



Important

Full contact has to be continuously established between the heating plate and the bead, even with lower pressure. While heating, if contact between them is lost somewhere along the circumference, welding has to be aborted and repeated.

4.4.3 Change-over Stage

After the end of the heating, or heat-soaking, stage, set the carriage mover lever on the hydraulic unit to its move-apart position in order to move the carriage to the far end. Then remove the heating element from in-between the pipes.

The change-over has to be followed immediately by the joining stage. The change-over time given for your welding situation in the tables in the Appendix (t_3) must not be exceeded. If it is, welding has to be aborted and repeated.

4.4.4 Joining and Cooling Stage

Set the carriage mover lever to its close-in position again in order to move the pipe butts in on each other and to build the joining pressure ($P_5 + P_t$) according to a consistent increase. Watch the value on the display screen. Building the joining pressure must correspond to a linearly increasing ramp and its duration must neither be longer nor shorter than indicated for your welding situation in the welding value tables in the Appendix at t_4 .

Once the joining pressure is reached and has stabilized at $P_5 + P_t$, the pressure will be kept at this level until the end of the joining phase (t_5 in the diagram). In this stage, the new joint also starts cooling down.

Pipe and fitting manufacturers may include data on how long the new joint should not be exposed to external strain. Also, the applicable welding standard may require a minimum cool-on time (t_6 in the diagram). In most cases, however, t_6 is not relevant to the welder.

4.4.5 End of Welding

The welding is finished at the end of a successful joining and cooling stage. The welder has to shut the pressure off from the pipes using either the manual pressure release valve or the START/SET key.

4.5 Performing an Electrofusion Joint

4.5.1 Connecting the Fitting

The machine switches to the electrofusion process when the welding cable is connected to the welding connector, which holds the heating element cable during butt welding. Then connect the connection terminals of the cable to the fitting and check for proper contact. Use terminal adapters if needed. The contact surfaces of the cable connection terminals or adapters and the fitting have to be clean. Dirty terminals may lead to improper welding and also to overheated and fused connection terminals. Protect the cable connectors against getting dirty at all times. Terminals and push-on adapters should be considered consumables and, therefore, have to be checked before every welding operation and replaced if damaged or dirty.



When the fitting is connected, the "No Contact" message, if applicable, disappears and the number of the next welding report appears (see Display 3).

4.5.2 Reading the Fitting Code with a Handheld Scanner

Only the bar code on the tag sticking on the fitting to be welded may be used. It is not acceptable to read the fitting code tag of a fitting of a different kind if the intended one is damaged or unreadable.

Read the fitting code by holding the scanner in front of the bar code at a distance of 5 to 10 cm (2 to 4 inches), where the red line indicates the reading area. Then push the reading button. If the data are correctly read, the welding unit confirms this by an audible signal and displays the decoded data on the screen (see Display 32).

Start ?		
Temp. :	20°C	
HST	315mm	58s
SAT	40.00V	0.80Ω

Display 32



The displayed values are the nominal welding parameters contained in the fitting bar code or computed based on these data. They are displayed before the actual resistance of the electrofusion fitting is measured. This means that even when the shown ohm value is o.k., a resistance error may still be detected (see Sect. 4.6). Only when the welding process starts, the display shows the actual, measured welding parameters.

The "Start ?" message means that the unit is ready to start the welding process. Check the read data and if you see that they are erroneous, delete them by pressing the STOP/RESET key. The read data are also deleted if the welding unit is disconnected from the fitting.

4.5.3 Entering Welding Parameters Manually

To be able to enter the welding parameters manually, you have first to connect the fitting to the welding unit with the welding cable. The manual input of the parameters can then be accessed by pressing the ↓ arrow key. The screen will show a menu as reproduced in Display 33, provided manual input is enabled in the configuration menu (see Sect. 4.1.2). In other words, the manual parameter input replaces reading the bar code of the fitting with a scanner.

Using the arrow keys \uparrow and \downarrow you can select "Enter Voltage/Time" or "Enter Fitting Code" (i.e., the numbers that represent the code of the fitting to be used). Confirm your selection by pressing the START/SET key.

If this option was chosen in the manual parameter input menu, a display like the one to the right appears on the screen. Use the alphanumeric keypad (see first Info in Sect. 4.1) to set the welding voltage and the welding time, according to the fitting manufacturer's instructions, then press the START/SET key to confirm your input. The "Start ?" message displayed after the confirmation by START/SET (see Display 32) indicates that the unit is ready for welding.

```
**  MANUAL INPUT  **  
  
>Enter Voltage/Time  
Enter Fitting Code
```

Display 33

If this option was chosen in the manual parameter input menu, the "Enter Fitting Code" display shows. The 24 characters of the fitting code to be entered display as asterisks (*). Use the alphanumeric keypad (see first Info in Sect. 4.1) to enter the code and press START/SET to confirm your input and have it decoded. If the code entered is not correct, a "Code Error" message appears; check the string of numbers and correct as needed. If the code is correct, the decoded data is displayed, and the "Start ?" message (see Display 32) indicates that the unit is ready to start welding.

```
Voltage/Time  
  
U= 40 V  t= 1000 s
```

Display 34

4.5.4 Starting the Welding Process



After the fitting bar code was read, the input of all traceability data that were enabled in the configuration menu (see Sect. 4.1.6, 4.2), is requested by the system.

After reading or entering the fitting code, the welding process can be started using the START/SET key, when the "Start ?" message is displayed and there is no indication of a problem.

Pressing the START/SET key will trigger a confirmation message "Pipe treated?," which in turn requires a confirmation with the START/SET key to start the welding proper.

4.5.5 Welding Process

The welding process is monitored for its entire duration applying the welding parameters contained in the fitting code. The welding voltage, the resistance, and the welding current are displayed in the lower line of the screen.

4.5.6 End of Welding

The welding process ends successfully if the actual welding time corresponds to the nominal welding time and the buzzer can be heard twice.

4.5.7 Cooling Time

The cooling time as given in the fitting manufacturer's instructions has to be respected. If the bar code provided by the fitting manufacturer contains cooling time data, it will be displayed at the end of the welding process and will be counted down to zero. This countdown can be acknowledged and canceled at any time by the STOP/RESET key. However, note that for that time the pipe-fitting joint which is still warm must not be subjected to an external force. No cooling time is displayed if the fitting code does not contain any such information.

4.6 Aborted Welding Process

If an error condition is detected, the machine aborts the welding pro-

cess and displays the error. However, this is only possible when welding according to the electrofusion process or the WeldControl mode of the butt-welding process. In the Manual Mode of butt welding, error detection is not available.

WELDING ABORTED
 Error Build-up Pres.
 229°C ACT. 1.5bar

Display 35

The error that made the welding abort is displayed on the screen (see Display 35). Additionally, in the welding diagram the LED that belongs to the welding stage with the malfunction starts flashing.

The errors listed in the following table can be displayed on the screen.

Type of Error	Description
a. Data Input	
Input Error	Error while entering data with the alphanumeric and cursor keys.
Code Error	Error while reading data from a bar code or an RFID card.
b. System and Conditions	
System Error	The welding system has to be disconnected immediately from both the power supply and the fitting or heating element/machine chassis. The auto-test has detected an error in the system. The welder must no longer be operated and has to be sent to an approved shop for check and repair.
Clock Error	The internal clock of the machine is defective; re-set the clock in the Configuration Menu.
Unit to Service	The recommended next service date for the welder is overdue. The service due message has to be acknowledged by pressing the START/SET key. Send the welding system to the manufacturer or an approved service point for service and check-up.
Power Supply Failure at Last Welding	The last welding is incomplete. The welding unit was disconnected from the power supply voltage while it was in progress. To go on using the unit, this error has to be acknowledged by pressing the STOP/RESET key.
Ambient Temperature high	Outside temperature outside the range from -20°C to +60°C.
Ambient Temperature low	Outside temperature outside the range from -20°C to +60°C.
Insufficient Voltage	The input voltage to the hydraulic and control unit is < 185 V; the welding process, if started, will likely be flawed and should not be started or repeated if the error appears during welding..
Excessive Voltage	The input voltage to the hydraulic and control unit is > 280 V; the welding process, if started, will likely be flawed and should not be started or repeated if the error appears during welding.
Overheated	The temperature of the control and hydraulic unit is too hot. Let the welding system cool down for about 1 hour.
Pressure Sensor Defective	The sensor indicated on the display (hydraulic pressure, heating element temperature, ambient temperature) is defective; where possible, check the connections/plug; have the machine inspected by an authorized service shop if needed.
Heating Sensor Defective	
Temperature Sensor Defective	
No Contact	There is no properly established electric contact between the welding unit and the fitting (check push-on terminal on fitting), or the heater coil is defective.
Printer not Ready (refers only to label tag printer)	The optional tag printer is not ready (possible reasons: no communication or faulty cable).
Download Cancelled	During data transfer or printing, an error condition occurred which could not be cleared.
Memory Full	The system memory is full of welding reports. Print or download the reports in memory or switch memory control off. Without memory control, a new report overwrites the oldest existing one.

Type of Error	Description
c. Butt-welding Process	
Temperature low	Heating element temperature will be increased automatically.
Temperature high	Heating element temperature will be reduced automatically.
Error Changeover	It took too long to retract the heating plate and bring the pipes to joining; welding will have to be repeated.
Error Drag Pressure	Impossible to determine the drag pressure; maybe pipes will have to be clamped once again; or the pressure is below 1 bar, which is not feasible for technical reasons.
Error Build-up Pressure	Build-up pressure too high or too low and was not re-adjusted in time.
Error Heat Soak Pressure	Heating pressure too high and was not re-adjusted in time.
Error Joining Pressure	Joining pressure too high or too low and was not re-adjusted in time.
Cooling Stopped	Operator has stopped the cooling time by pressing the STOP/REST key.
Error Plate Temperature	Heating element temperature is out of tolerance; impossible to re-adjust the temperature; maybe the ambient temperature was too low.
d. Electrofusion Process	
Low Voltage	The input voltage is below 175 volts. If the error condition persists for longer than 15 seconds, the welding process will be aborted. If the voltage goes down below 170 volts, the welding process will abort immediately.
Overvoltage	The input voltage is over 290 volts. If the error condition persists for longer than 15 seconds, the welding process will be aborted.
Resistance Error	The resistance value of the connected fitting is out of the read tolerance.
Frequency Error	The frequency of the input voltage is out of tolerance (42 Hz - 69 Hz)..
Low Current	The message is displayed if there is a momentary current failure or if the current decreases by more than 15% per second for 3 seconds.
Excess Current	The output current value is in excess; possible causes: short-circuit in the heater coil or the welding cable. During the start stage the upper abort threshold equals 1.18 times the value at start, in any other case the upper limit depends on the load value and is calculated as the current at start plus 15%.
Heater Coil Error	The dynamic current value during welding differs by more than 15% from the required value, indicating a short-circuit in the heater coil.

4.7 Using ViewWeld to View Welding Reports and Print Tags

The ViewWeld feature offers viewing an abstracted version of the welding report recorded during the last welding process and printing it as a label tag to be affixed to the joint on the optionally available tag printer. The ViewWeld abstract shows the report number, the date and time of the welding and the welding parameters along with an evaluation of the quality of the joint/welding operation (see Display 36).

To call the ViewWeld abstract of a welding report, press the \uparrow key in the start screen (see Display 3). To print a tag of this operation, press the START/SET key in the ViewWeld screen.



The ViewWeld abstract that shows on the screen depends on the currently selected welding process. If the welding cable

for electrofusion fittings is connected to the hydraulic and control unit, the report of the last electrofusion joint is displayed. If the heating element is connected to it, the report of the last butt welding shows on the screen. If no cable at all is connected the last report of all, no matter whether butt welding or electrofusion operation, is displayed.

```
0015 24.02.13 09:33
M/B MON HST 315
0058s 025.0V 1.57Ω
No Error
```

After the ViewWeld abstract was accessed, it is possible to browse through all abstracts in memory by pressing the ⇐ and ⇒ cursor keys.

5 Downloading the Reports

Interface

USB A Interface Port

for connecting USB mass storage media (such as a memory stick)

The interface port complies with the USB version 2.0 specification (i.e., maximum data rate of 480 megabits per second).



Important

Before transferring data, it is highly recommended to switch the welding unit off and on again. If this fails to happen, there is a risk of data transfer failure, or reports in the welding unit may be corrupted.



Important

When transferring welding reports to a USB stick, always be sure to wait until the display shows the "Download finished" message before you disconnect the USB stick from the product. If you disconnect it too early, the unit may ask you whether you want to delete the reports in memory, although they were not properly transferred. In this case, if you delete the contents of the report memory, the welding reports would be irrevocably lost and would not be available elsewhere either.

5.1 Selecting the File Format and the Welding Process

Connecting the storage media causes the the screen to appear in which the format of the output file with the welding reports can be selected: a PDF file with an abstracted or extended version of the report or the format of the welding data management application DataWork. Using the ↑ and ↓ arrow keys, select the file type you need and confirm your selection by pressing the START/SET key.

```
* Select File Type *
DataWork File
>PDF Abstract
PDF Ext'd Report
```

Display 37

The Service Report option is not important for normal operation. In the scope of computer-assisted unit service, this report lists the events related to the maintenance of the welding unit.

After a file format was selected, a similar screen allows selecting the welding reports of one or both of the possible welding processes. It is possible to select the download of the reports of butt-welding operations only, of electrofusion joints only, or all reports, no matter which welding process they were saved from. The reports selected on this screen will then be sent to the USB mass media in the previously selected format.

```
Butt Welding
>Electrofusion
Both
```

Display 38

5.2 Downloading All Reports

After the file type and the welding process were selected, the next screen offers a "Print All Reports" option. Selecting it will download all welding reports, or all of the previously selected welding process, currently in system memory in the previously selected file format.

5.3 Downloading by Commission Number, Date or Report Range

After the file type and the welding process were selected, the next screen offers a "By Commission Number," a "By Date Range," and a "By Report Range" options. Depending on the selection, the ↑ and ↓ arrow keys can be used to select from the commissions currently in system memory the desired one, of which the reports should be downloaded, or the alphanumeric keypad can be used (see first info in Sect. 4.1) to enter a start date and an end date, or the first and the last report, that define a range of dates or a range of reports of which the reports should be downloaded. When you press the START/SET key, you cause the selected reports to be transferred to the storage media.

5.4 Understanding the Report Download Process

The download starts automatically after a selection was made among the options. Wait for all the selected reports to transfer and the "Download completed" message to appear on the screen.

If a problem occurs while the download is in progress, a "Not ready" message shows. After the problem condition is cleared, the download resumes automatically.



If the welding unit recognizes a problem that cannot be cleared while the data transfer is in progress, it does not resume the process and displays a "Download cancelled" error message. To acknowledge this error, press the START/SET key.

5.5 Deleting Data from Memory

The report data in memory can be deleted only after all welding reports were transferred, which is indicated by the "Download completed" message. When the storage media is unplugged, a "Delete Memory" message appears. If the START/SET key is pressed at this point, a further confirmation message "Delete Memory, sure?" is shown, which has to be confirmed by pressing the START/SET key once again. Then, the report data in memory are deleted.

5.6 Keeping Data in Memory

When the cable or storage media is unplugged, a "Delete Memory" message is displayed. Press the STOP/RESET key to keep the current report data in memory. They can then be printed off once again.



Make a habit of handling the internal storage as described at the beginning of Sect. 5, to maintain data integrity and avoid any inadvertent deletion of the reports in memory.

6 Service and Repair

As the product is used in applications sensitive to safety considerations, it may be serviced and repaired only on our premises or by partners

who were specifically trained and authorized by us. Thus, constantly high standards of operation quality and safety are maintained.



Important

Non-compliance with this provision will dispense the manufacturer from any warranty and liability claims for the product and any consequential damage.

7 Service and Repair Contact

HÜRNER Schweißtechnik
Nieder-Ohmener Str. 26
35325 Mücke, Germany

Tel.: +49 (0)6401 9127 0
Fax: +49 (0)6401 9127 39

Web: www.huerner.de

E-mail: info@huerner.de



We reserve the right to change technical specifications of the product without prior notice.

8 Accessories/Parts for the Product

Facing Tool Blade for HÜRNER WeldControl EF 250

Connection Terminal 4.7 threaded

(fitting connector of welding cable), compatible with Uponor,
DURA-Pipe, Simona, Strengheld, Plasson 216 - 023 - 430

Push-on Adapter FF flat

compatible with Friatec 216 - 010 - 070

Push-on Adapter FF round 4.0

compat. w/ Friatec, GF, agru, Wavin, Euro Standard 216 - 010 - 080

Push-on Adapter FF pin

compatible with Friatec Friafit (waste water) 216 - 010 - 400

Push-on Adapter GF

compatible w/ GF, agru, Wavin, with free wires 216 - 010 - 090

Push-on Elbow Adapter 4.7 - 4.7 90°

216 - 010 - 580

Adapter Bag

216 - 030 - 310

Welder/Operator ID Card

216 - 080 - 031

Software DataWork for Windows

216 - 080 - 505

USB Stick

300 - 010 - 154



Only genuine spare parts are acceptable. The use of non-genuine parts voids any and all liability and warranty on the part of the manufacturer.

For consultation and ordering spare parts, refer to the seller or manufacturer of the product.

Schweißtabellen
Welding Value Tables
Paramètres de soudage

HÜRNER WeldControl EF 200



Technische Änderungen an der Maschine bleiben vorbehalten.

We reserve the right to change technical specs of the machine without prior notice.

Nous nous réservons le droit d'apporter des modifications techniques sans préavis.

PE 80 / PE 100 DVS 2207-1 (09/2005)		HÜRNER WeldControl EF 200 Zylinder/Cylinder/Vérin 3,15 cm ²				Angleichen Bead Build-up		Anwärmen Heating		Um- stellen Change- over	Fügerampe (t ₃), Fügen u. Abkühlen Pressure Ramp (t ₄), Joining and Cooling		
Durchmesser Diameter mm	Wandstärke Wall Thickn. mm	Ø / Wand Ø / Wall SDR	Versatz Align Offset mm	Temperatur Temperature °C (PE 80)	Temperatur Temperature °C (PE 100)	P ₁ bar	Wulst Bead mm	P ₂ max. bar	t ₂ sec	t ₃ max. sec	t ₄ sec	P ₅ bar	t ₆ min
63	2,4	26	0,3	220	220	2,0	0,5	0,0	45	5	5	2,0	6
63	3,0	21	0,3	220	220	2,5	0,5	0,0	45	5	5	2,5	6
63	3,6	17,6	0,4	220	220	3,0	0,5	0,5	45	5	5	3,0	6
63	3,7	17	0,4	219	220	3,0	0,5	0,5	45	5	5	3,0	6
63	4,6	13,6	0,5	218	220	4,0	1,0	0,5	46	5	5	4,0	7
63	5,7	11	0,6	217	220	4,5	1,0	0,5	57	5	6	4,5	8
63	7,0	9	0,7	216	220	5,5	1,0	0,5	70	6	6	5,5	10
63	8,5	7,4	0,9	215	220	6,5	1,5	1,0	85	7	7	6,5	12
75	2,9	26	0,3	220	220	3,0	0,5	0,0	45	5	5	3,0	6
75	3,6	21	0,4	220	220	3,5	0,5	0,5	45	5	5	3,5	6
75	4,3	17,6	0,5	219	220	4,5	0,5	0,5	45	5	5	4,5	6
75	4,4	17	0,5	219	220	4,5	0,5	0,5	45	5	5	4,5	6
75	5,5	13,6	0,6	217	220	5,5	1,0	0,5	55	5	5	5,5	8
75	6,8	11	0,7	216	220	6,5	1,0	0,5	68	6	6	6,5	10
75	8,3	9	0,9	215	220	8,0	1,5	1,0	83	7	7	8,0	12
75	10,1	7,4	1,0	213	220	9,5	1,5	1,0	101	7	7	9,5	14
90	3,5	26	0,4	220	220	4,5	0,5	0,5	45	5	5	4,5	6
90	4,3	21	0,5	219	220	5,5	0,5	0,5	45	5	5	5,5	6
90	5,1	17,6	0,5	218	220	6,0	1,0	0,5	51	5	5	6,0	7
90	5,3	17	0,6	218	220	6,5	1,0	0,5	53	5	5	6,5	7
90	6,6	13,6	0,7	216	220	8,0	1,0	1,0	66	6	6	8,0	9
90	8,2	11	0,9	215	220	10,0	1,5	1,0	82	7	7	10,0	11
90	10,0	9	1,0	213	220	11,5	1,5	1,5	100	7	7	11,5	13
90	12,2	7,4	1,3	211	220	14,0	2,0	1,5	122	8	8	14,0	15
110	4,2	26	0,5	219	220	6,5	0,5	0,5	45	5	5	6,5	6
110	5,2	21	0,6	218	220	8,0	1,0	1,0	52	5	5	8,0	7
110	6,2	17,6	0,7	217	220	9,5	1,0	1,0	62	6	6	9,5	9
110	6,5	17	0,7	217	220	10,0	1,0	1,0	65	6	6	10,0	9
110	8,1	13,6	0,9	215	220	12,0	1,5	1,5	81	6	6	12,0	11
110	10,0	11	1,0	213	220	14,5	1,5	2,0	100	7	7	14,5	14
110	12,2	9	1,3	211	220	17,5	2,0	2,0	122	8	8	17,5	16
110	14,9	7,4	1,5	209	220	21,0	2,0	2,5	149	8	9	21,0	19



Angleichdruck *Bead Build-up Pressure* = P₁ + P_t (Bewegungsdruck *Drag Pressure*)
 Anwärmdruck *Heat Soaking Pressure* = P₂ + P_t (Bewegungsdruck *Drag Pressure*)
 Fügedruck *Joining Pressure* = P₅ + P_t (Bewegungsdruck *Drag Pressure*)

PE 80 / PE 100 DVS 2207-1 (09/2005)		HÜRNER WeldControl 200-R Zylinder/Cylinder/Vérin 3,15 cm ²				Angleichen <i>Bead Build-up</i>		Anwärmen <i>Heating</i>		Um- stellen Change- over	Fügerampe (t₂), Fügen u. Abkühlen Pressure Ramp (t₂), Joining and Cooling		
Durchmesser <i>Diameter</i>	Wandstärke <i>Wall Thickn.</i>	Ø / Wand Ø / Wall	Versatz <i>Align Offset</i>	Temperatur <i>Temperature</i>	Temperatur <i>Temperature</i>	P ₁	Wulst Bead	P ₂ max.	t ₂	t ₃ max.	t ₄	P ₅	t ₆
mm	mm	SDR	mm	°C (PE 80)	°C (PE 100)	bar	mm	bar	sec	sec	sec	bar	min
125	4,8	26	0,5	218	220	8,5	1,0	1,0	48	5	5	8,5	6
125	6,0	21	0,6	217	220	10,5	1,0	1,0	60	6	6	10,5	8
125	7,1	17,6	0,7	216	220	12,5	1,5	1,5	71	6	6	12,5	10
125	7,4	17	0,8	216	220	13,0	1,5	1,5	74	6	6	13,0	10
125	9,2	13,6	1,0	214	220	15,5	1,5	2,0	92	7	7	15,5	13
125	11,4	11	1,2	212	220	19,0	1,5	2,5	114	8	8	19,0	15
125	13,9	9	1,4	210	220	23,0	2,0	3,0	139	9	9	23,0	18
125	16,9	7,4	1,7	208	220	27,0	2,0	3,5	169	9	10	27,0	22
140	5,4	26	0,6	218	220	10,5	1,0	1,0	54	5	5	10,5	7
140	6,7	21	0,7	216	220	13,0	1,0	1,5	67	6	6	13,0	9
140	8,0	17,6	0,8	215	220	15,5	1,5	2,0	80	6	6	15,5	10
140	8,2	17	0,9	215	220	16,0	1,5	2,0	82	7	7	16,0	12
140	10,3	13,6	1,1	213	220	19,5	1,5	2,5	103	7	7	19,5	14
140	12,7	11	1,3	211	220	24,0	2,0	3,0	127	8	8	24,0	17
140	15,6	9	1,6	209	220	29,0	2,0	3,4	156	9	10	29,0	20
140	18,9	7,4	1,9	207	220	34,0	2,0	4,5	190	10	11	34,0	24
160	6,2	26	0,7	217	220	14,0	1,0	1,5	62	6	6	14,0	9
160	7,6	21	0,8	215	220	17,0	1,5	2,0	76	6	6	17,0	10
160	9,1	17,6	1,0	214	220	20,5	1,5	2,5	91	7	7	20,5	12
160	9,4	17	1,0	214	220	21,0	1,5	2,5	95	7	7	21,0	13
160	11,8	13,6	1,2	212	220	26,0	1,5	3,0	119	8	8	26,0	16
160	14,5	11	1,5	210	220	31,5	2,0	4,0	146	9	9	31,5	19
160	17,8	9	1,8	207	220	37,5	2,0	5,0	179	10	11	37,5	23
160	21,6	7,4	2,2	205	220	44,5	2,5	5,5	219	10	12	44,5	27
180	6,9	26	0,7	216	220	17,5	1,0	2,0	69	6	6	17,5	10
180	8,6	21	0,9	215	220	22,0	1,5	2,5	86	7	7	22,0	11
180	10,2	17,6	1,1	213	220	25,5	1,5	3,0	102	7	7	25,5	13
180	10,6	17	1,1	213	220	26,5	1,5	3,5	107	7	7	26,5	14
180	13,2	13,6	1,4	211	220	32,5	2,0	4,0	133	8	9	32,5	17
180	16,4	11	1,7	208	220	40,0	2,0	5,5	165	9	10	40,0	21
180	20,0	9	2,0	206	220	47,5	2,5	6,0	202	10	11	47,5	25
180	24,3	7,4	2,5	204	220	56,5	2,5	7,5	245	12	23	56,5	30
200	7,7	26	0,8	215	220	22,0	1,5	2,5	77	6	6	22,0	10
200	9,5	21	1,0	214	220	27,0	1,6	3,5	96	7	7	27,0	12
200	11,4	17,6	1,2	212	220	32,0	1,5	4,0	115	8	8	32,0	15
200	11,8	17	1,2	212	220	33,0	1,5	4,0	119	8	8	33,0	16
200	14,7	13,6	1,5	210	220	40,5	2,0	5,0	148	9	9	40,5	19
200	18,2	11	1,9	207	220	49,5	2,0	6,5	183	10	11	49,5	23
200	22,2	9	2,3	205	220	59,0	2,5	7,5	224	11	12	59,0	28
200	27,0	7,4	2,8	202	220	69,5	3,0	9,0	272	12	14	69,5	34



Angleichdruck *Bead Build-up Pressure* = P₁ + P_t (Bewegungsdruck *Drag Pressure*)
 Anwärmdruck *Heat Soaking Pressure* = P₂ + P_t (Bewegungsdruck *Drag Pressure*)
 Fügedruck *Joining Pressure* = P₅ + P_t (Bewegungsdruck *Drag Pressure*)

PP DVS 2207-11 (02/2017)		HÜRNER WeldControl 200-R Zylinder/Cylinder/Vérin 3,15 cm ²			Angleichen <i>Bead Build-up</i>		Anwärmen <i>Heating</i>		Um- stellen Change- over	Fügerampe (t ₄), Fügen u. Abkühlen Pressure Ramp (t ₄), Joining and Cooling		
Durchmesser Diameter mm	Wandstärke Wall Thickn. mm	Ø / Wand Ø / Wall SDR	Versatz Alignment Offset mm	Temperatur Temperature °C	P ₁ bar	Wulst Bead mm	P ₂ max. bar	t ₂ sec	t ₃ max. sec	t ₄ sec	P ₅ bar	t ₆ min
63	1,5	41	0,2	210	0,5	0,5	0,0	53	5	6	0,5	6,5
63	1,9	33	0,2	210	1,0	0,5	0,0	53	5	6	1,0	6,5
63	2,4	26	0,3	210	1,0	0,5	0,0	53	5	6	1,0	6,5
63	3,6	17,6	0,4	210	2,0	0,5	0,0	53	5	6	2,0	6,5
63	5,7	11	0,6	210	3,0	0,5	0,0	66	5	6	3,0	8,0
63	7,0	9	0,7	210	3,5	0,5	0,0	81	6	7	3,5	9,5
63	8,5	7,4	0,9	210	4,5	1,0	0,5	97	6	8	4,5	11,5
63	10,5	6	1,1	210	5,5	1,0	0,5	119	7	9	5,5	13,5
75	1,8	41	0,2	210	1,0	0,5	0,0	53	5	6	1,0	6,5
75	2,3	33	0,3	210	1,5	0,5	0,0	53	5	6	1,5	6,5
75	2,9	26	0,3	210	2,0	0,5	0,0	53	5	6	2,0	6,5
75	4,3	17,6	0,5	210	3,0	0,5	0,0	53	5	6	3,0	6,5
75	6,8	11	0,7	210	4,5	0,5	0,5	79	6	7	4,5	9,5
75	8,3	9	0,9	210	5,5	1,0	0,5	95	6	8	5,5	11,0
75	10,1	7,4	1,0	210	6,5	1,0	0,5	114	7	10	6,5	13,0
75	12,5	6	1,3	210	7,5	1,0	0,5	140	7	11	7,5	16,0
90	2,2	41	0,3	210	1,5	0,5	0,0	53	5	6	1,5	6,5
90	2,7	33	0,3	210	2,0	0,5	0,0	53	5	6	2,0	6,5
90	3,5	26	0,4	210	3,0	0,5	0,0	53	5	6	3,0	6,5
90	5,1	17,6	0,5	210	4,0	0,5	0,5	60	5	6	4,0	7,0
90	8,2	11	0,9	210	6,5	1,0	0,5	94	6	8	6,5	11,0
90	10,0	9	1,0	210	7,5	1,0	0,5	113	7	9	7,5	13,0
90	12,2	7,4	1,3	210	9,0	1,0	0,5	137	7	11	9,0	15,5
90	15,0	6	1,5	210	11,0	1,0	1,0	165	8	14	11,0	19,0
110	2,7	41	0,3	210	2,5	0,5	0,0	53	5	6	2,5	6,5
110	3,3	33	0,4	210	3,5	0,5	0,0	53	5	6	3,5	6,5
110	4,2	26	0,5	210	4,0	0,5	0,5	53	5	6	4,0	6,5
110	6,2	17,6	0,7	210	6,0	0,5	0,5	72	6	7	6,0	8,5
110	10,0	11	1,0	210	9,5	1,0	1,0	113	7	9	9,5	13,0
110	12,2	9	1,3	210	11,5	1,0	1,0	137	7	11	11,5	15,5
110	14,9	7,4	1,5	210	14,0	1,0	1,0	164	8	13	14,0	19,0
110	18,3	6	1,9	210	16,5	1,0	1,5	199	9	16	16,5	23,0
125	3,0	41	0,3	210	3,5	0,5	0,0	53	5	6	3,5	6,5
125	3,8	33	0,4	210	4,5	0,5	0,5	53	5	6	4,5	6,5
125	4,8	26	0,5	210	5,5	0,5	0,5	56	5	6	5,5	7,0
125	7,1	17,6	0,8	210	8,0	1,0	0,5	82	6	7	8,0	9,5
125	11,4	11	1,2	210	12,5	1,0	1,0	129	7	10	12,5	15,0
125	13,9	9	1,4	210	15,0	1,0	1,5	154	8	13	15,0	18,0
125	16,9	7,4	1,7	210	18,0	1,0	1,5	185	8	15	18,0	21,5
125	20,1	6	2,0	210	21,0	1,5	2,0	216	10	18	21,0	25,5



Angleichdruck *Bead Build-up Pressure* = P₁ + P_t (Bewegungsdruck *Drag Pressure*)
 Anwärmdruck *Heat Soaking Pressure* = P₂ + P_t (Bewegungsdruck *Drag Pressure*)
 Fügedruck *Joining Pressure* = P₅ + P_t (Bewegungsdruck *Drag Pressure*)

PP DVS 2207-11 (02/2017)		HÜRNER WeldControl 200-R Zylinder/Cylinder/Vérin 3,15 cm ²			Angleichen <i>Bead Build-up</i>		Anwärmen <i>Heating</i>		Um- stellen Change- over	Fügerampe (t ₄), Fügen u. Abkühlen Pressure Ramp (t ₄), Joining and Cooling		
Durchmesser <i>Diameter</i>	Wandstärke <i>Wall Thickn.</i>	Ø / Wand Ø / Wall	Versatz <i>Alignment Offset</i>	Temperatur <i>Temperature</i>	P ₁	Wulst Bead	P ₂ m _{ax.}	t ₂	t ₃ m _{ax.}	t ₄	P ₅	t ₆
mm	mm	SDR	mm	°C	bar	mm	bar	sec	sec	sec	bar	min
140	3,4	41	0,4	210	4,5	0,5	0,5	53	5	6	4,5	6,5
140	4,2	33	0,5	210	5,5	0,5	0,5	53	5	6	5,5	6,5
140	5,4	26	0,6	210	7,0	0,5	0,5	63	5	6	7,0	7,5
140	8,0	17,6	0,8	210	10,5	1,0	1,0	92	6	8	10,5	10,5
140	12,7	11	1,3	210	16,0	1,0	1,5	142	7	12	16,0	16,5
140	15,6	9	1,6	210	19,0	1,0	1,5	172	8	14	19,0	20,0
140	18,9	7,4	1,9	210	22,5	1,0	2,0	205	9	17	22,5	24,0
140	23,3	6	2,4	210	27,0	1,5	2,5	246	10	20	27,0	29,0
160	3,9	41	0,4	210	6,0	0,5	0,5	53	5	6	6,0	6,5
160	4,8	33	0,5	210	7,0	0,5	0,5	56	5	6	7,0	7,0
160	6,2	26	0,7	210	9,5	0,5	0,5	72	6	7	9,5	8,5
160	9,1	17,6	0,9	210	13,5	1,0	1,0	104	6	9	13,5	12,0
160	14,5	11	1,5	210	21,0	1,0	2,0	160	8	13	21,0	18,5
160	17,8	9	1,8	210	25,0	1,0	2,5	194	9	16	25,0	22,5
160	21,6	7,4	2,2	210	39,5	1,5	2,5	230	10	19	39,5	27,0
160	26,7	6	2,7	210	35,5	2,0	3,5	277	11	26	35,5	33,0
180	4,4	41	0,5	210	7,5	0,5	0,5	53	5	6	7,5	6,5
180	5,5	33	0,6	210	9,5	0,5	0,5	64	5	6	9,5	7,5
180	6,9	26	0,7	210	11,5	0,5	1,0	80	6	7	11,5	9,5
180	10,2	17,6	1,1	210	17,0	1,0	1,5	116	7	10	17,0	13,5
180	16,4	11	1,7	210	26,5	1,0	2,5	180	8	15	26,5	21,0
180	20,0	9	2,0	210	31,5	1,5	3,0	215	9	18	31,5	25,0
180	24,3	7,4	2,5	210	37,5	1,5	3,5	255	11	21	37,5	30,0
180	30,0	6	3,0	210	44,5	2,0	4,0	304	12	29	44,5	36,5
200	4,9	41	0,5	210	9,5	0,5	0,5	57	5	6	9,5	7,0
200	6,1	33	0,6	210	11,5	0,5	1,0	71	6	7	11,5	8,5
200	7,7	26	0,8	210	14,5	1,0	1,5	89	6	8	14,5	10,5
200	11,4	17,6	1,2	210	21,0	1,0	2,0	129	7	10	21,0	15,0
200	18,2	11	1,9	210	33,0	1,0	3,0	198	9	16	33,0	23,0
200	22,2	9	2,3	210	39,0	1,5	3,5	236	10	19	39,0	27,5
200	27,0	7,4	2,7	210	46,5	2,0	4,5	279	11	26	46,5	33,0
200	33,3	6	3,4	210	55,0	2,0	5,5	331	13	32	55,0	40,5



Angleichdruck *Bead Build-up Pressure* = P₁ + P_t (Bewegungsdruck *Drag Pressure*)
 Anwärmdruck *Heat Soaking Pressure* = P₂ + P_t (Bewegungsdruck *Drag Pressure*)
 Fügedruck *Joining Pressure* = P₅ + P_t (Bewegungsdruck *Drag Pressure*)