

HÜRNER

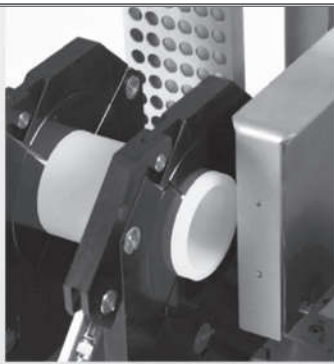

HÜRNER

SCHWEISSTECHNIK

Bedienungsanleitung • User's Manual • Manuel utilisateur

CNC ECO 1200

v. 2.0



HÜRNER SCHWEISSTECHNIK GmbH

Nieder-Ohmener Str. 26
35325 Mücke (Atzenhain)



+49 (0)6401 91 27 0



+49 (0)6401 91 27 39



info@huerner.de



<http://www.huerner.de>

HÜRNER

SCHWEISSTECHNIK

Version März 2015

Contents

1	Introduction	5
2	Safety Messages	5
2.1	The User's Manual.....	5
2.2	Explaining Icons	5
2.3	Operating the Product Safely.....	5
2.4	Owner and Operator Obligations.....	6
2.5	Intended Use	7
2.6	Required Worksite Conditions	7
2.7	Warranty.....	7
2.8	Transport and Storage	7
2.9	Identifying the Product	7
3	Understanding the Machine	8
3.1	Included Components.....	8
3.2	Control Panel.....	8
3.3	Connectors.....	9
3.4	Technical Specifications	9
3.5	Overview of the Welding Process	10
4	Operation	11
4.1	Start of Operation, Switching the Machine on.....	11
4.2	Setting the Default Configuration of the Machine	12
4.3	Entering Traceability Data	15
4.4	Entering Pipe or Fitting Parameters	15
4.5	Performing the Welding Process.....	16
4.5.1	Facing the Pipe Butts	16
4.5.2	Checking Pipe Alignment.....	16
4.5.3	Possibility to Change Welding Parameters.....	16
4.5.4	Inserting and Monitoring the Heating Element	17
4.5.5	Bead Build-up Stage	17
4.5.6	Heating Stage.....	18
4.5.7	Change-over Stage.....	18
4.5.8	Joining and Cooling Stage	18
4.5.9	End of Welding	18
4.5.10	Printing Label Tags.....	18
4.6	Aborted Welding Process	19
5	Downloading Welding Reports.....	20
5.1	Selecting the Reports to Download.....	20
5.2	Saving the Reports to a Storage Media.....	20
5.3	Deleting Data in Memory.....	21
5.4	Keeping Data in Memory	21
6	Service and Repair.....	21
7	Service and Repair Contact.....	21
8	Accessories/Parts for the Product	22



The success of the jointing operation depends on consistent compliance with the nominal pressures, times, and temperatures of the welding. The correct pressure value depends on the section of the cylinder of the welding machine. Therefore, using the hydraulics with another basic machine chassis than the one it came with, will result in a flawed and/or inconsistent welded joint. If the hydraulic and control unit must exceptionally be used with another machine chassis, core settings of the machine have to be changed. Only the manufacturer and authorized service points are able to make this change. To this end, get in touch with them.

1 Introduction

Dear Customer:

Thank you very much for purchasing our product. We are confident that it will bring you success and meet your expectations.

The development, manufacture, and check of the heating element butt-welding machine **HÜRNER CNC ECO 1200** has been performed with a view to superior operation safety and user-friendliness. The machine was manufactured and checked according to state-of-the-art technology and widely recognized safety regulations, as they are applied.

To ensure maximum operation safety, please conform to the appropriate messages in this booklet and the regulations for the prevention of accidents.

Thank you.

2 Safety Messages

2.1 The User's Manual

This User's Manual contains important instructions for the intended and safe operation of the product. Every person who operates the product has to conform to the instructions of this manual. All rights, in particular the right to copy or reproduce (in print or electronic form) and distribute as well as to translate, are reserved and subject to prior written consent.

2.2 Explaining Icons

The following expressions and icons are used in this User's Manual to refer to safety-related issues:



This icon indicates that non-compliance may result in a hazardous situation that possibly causes bodily injury or material damage.



This icon indicates important messages related to the correct use of the product. Non-compliance may cause problems of operation and damage to the product.



This icon indicates tips and useful information for using the product more efficiently and more economically.

2.3 Operating the Product Safely

For your own safety, comply with the following instructions

- Protect the power supply cord and the hydraulic pressure lines from cutting edges. Have an authorized service shop replace damaged cables or lines immediately.
- The product may be operated and serviced exclusively by authorized staff who were briefed on it.
- The product may be operated only when observed.
- Before operating the product, always check for damaged parts and have them repaired or replaced by an authorized service shop as needed.
- The cover caps of the hydraulic lines and interface port have to

be closed during transport in order to prevent contaminants and humidity from entering the hydraulic and control unit.

- Mains suppliers' wiring rules, VDE provisions, DIN/CEN standards, and applicable national legislation have to be respected.
- Without prior authorization by the manufacturer, modifications to the product are unacceptable.



Caution

Parts Under Power

After opening the machine or removing the cover, parts of it are accessible that may be under power. The machine may be opened exclusively by an authorized service shop.



Caution

Pipe Facing Tool

Start the pipe facing tool only after it was inserted into the machine and carry it only by the handle, never by the disk enclosure.

It is unacceptable to remove shavings from the machine while the facing process is in progress. Make sure nobody is present in this danger zone.



Caution

Heating Element

When working with the machine, be extremely cautious while the heating element is used. Since the heating element presents a temperature of more than 200°C during the welding process, it is absolutely indispensable that operators wear suitable protective gloves. Bear in mind that the heating element will remain hot for a while after it was turned off.



Caution

Danger of Bruises and Injury

Do not remain in the danger zone while the machine carriage moves apart or closes in, and be sure not to have your arms or legs between the moving and the fixed carriage of the machine.



Caution

Acceptable Work Conditions

The work zone has to be clean and has to have proper lighting. It is dangerous to operate while it is raining, in a humid environment, or close to flammable liquids. In regard of this, acceptable work conditions have to be ensured (tent, heating, etc.).



Info

User's Manual

The User's Manual has to be available at any time on the site where the machine is used. If the User's Manual becomes incomplete or unreadable, replace it without delay. Feel free to contact us for assistance.

2.4 Owner and Operator Obligations

- The machine may be operated exclusively by persons who are familiar with the applicable regulations, the guidelines for the prevention of accidents, and the User's Manual. The owner/manager shall provide the worker operating the machine with the User's Manual and shall make sure that the operator reads and understands it.
- The machine may be operated only when observed. Welders must have been briefed properly on the operation of the machine or must have participated in a dedicated training. The operating/owning organization engages to check at reasonable intervals if the machine is operated by the welders as intended and under proper guidelines of occupational safety.

- The machine must be operated only when in proper state of repair and for one of the intended uses. Before welding, the welder is required to make sure that the state of the machine is in order.
- The user has to make sure that only one person is present in the work zone where the machine is operating.



Important

During transport, the facing tool and the heating element have to be placed into the provided carrying rack at all times.

2.5 Intended Use

The Butt-Welding Machine is intended exclusively for joining plastic pipes and fittings according to the butt-welding process with heating element. See Section 3 for an overview of the welding process enabled by this machine.

The notion of intended use also includes:

- Compliance with the instructions in the User's Manual
- Observation of all service and maintenance intervals



Important

All uses other than those mentioned above are not allowed and will cancel any and all liability or warranty by the manufacturer. Unintended use may cause considerable hazards and material damage.

2.6 Required Worksite Conditions

- The conditions have to fully ensure that the machine cannot slide.
- Worksite access limitations have to be provided. Appropriate equipment to achieve this can be ordered with the manufacturer.
- The machine must never be used if there are foreign bodies or objects in the work area; in particular, it must not be started if anything obstructs the smooth movement of any movable part or component of the machine.

2.7 Warranty

Warranty claims may be raised only if the conditions for warranty given in the General Terms and Conditions of Sale and Delivery obtain.

2.8 Transport and Storage

When the product is transported or stored, the hydraulic tubing should **not be detached or squeezed**. For transporting the pipe facing tool and the heating element, use the provided carrying rack at all times.



Caution

Because of the heavy weight of the basic machine chassis of the butt welder, it has to be transported or moved on site by two persons and/or using appropriate hoisting tools as required.

2.9 Identifying the Product

Every product is identified by a name plate. It shows the model ("Typ"), the serial number ("Seriennr."), the most important specifications of the hydraulic unit, and the manufacturer. The first two digits of the serial number represent the year of manufacture.

Stumpfschweißmaschine	
Typ	CNC 1200 ECO
Seriennr.	120007204
Netz	230V 50Hz 800W
Gewicht	44kg Baujahr: 2012
Hersteller	HÜRNER Schweißtechnik GmbH Nieder-Ohmener Str. 26 D - 32325 Mücke

3 Understanding the Machine

This butt-welding machine for plastics can be used both as an on-site and as a workshop installation, for jointing operations pipe-to-pipe, but also for processing tees and elbows (see also the first paragraphs of Sect. 4.5 for more detailed information on this).

It has basically three functions:

- Controlling the welding process
- Monitoring all the relevant parameters during the welding process
- Generating a log protocol/report of the welding process

3.1 Included Components

The product ships with the following components:

- Machine chassis ("basic machine") to secure the parts to be welded
- Electrical heating element with anti-stick coating
- Electrical facing tool
- Carrying and storage rack for heating element and facing tool
- Hydraulic and control unit with control panel
- Reducer inserts for clamps of machine chassis for the following nominal pipe sizes: O.D. 630, 710, 800, 900, 1000 mm

3.2 Control Panel

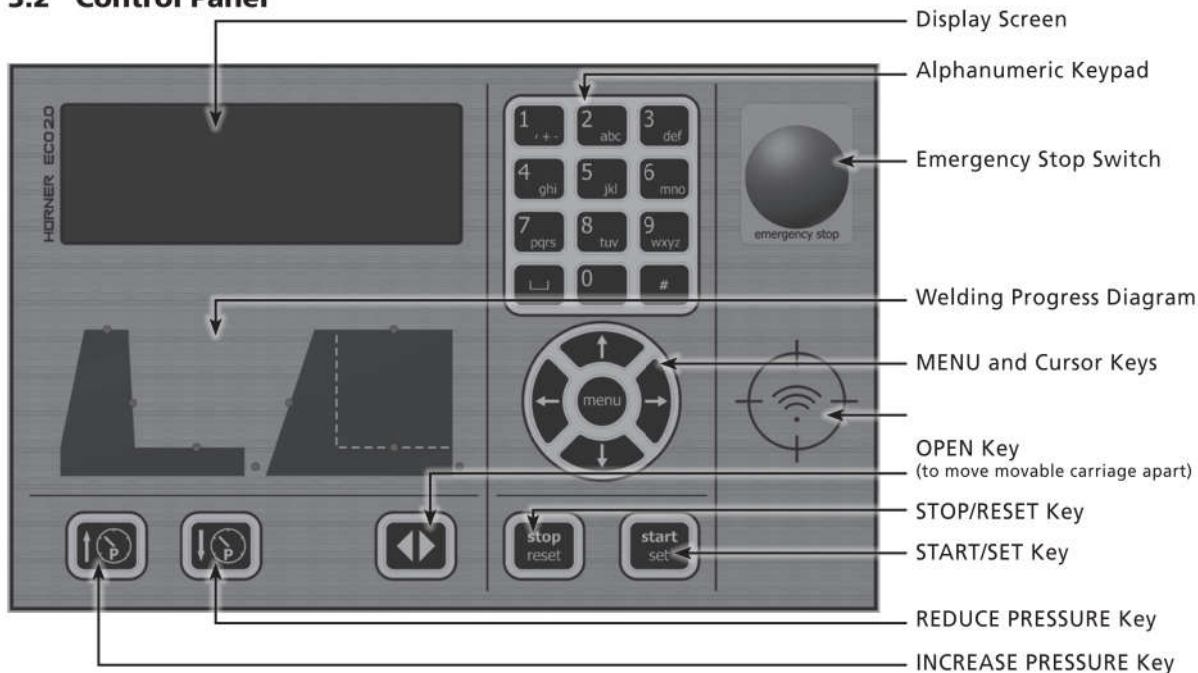

Emergency Stop Switch on the Control Unit

An Emergency Stop switch is provided on the control unit to abort the welding process if needed in order to avoid hazardous situations. If the Emergency Stop switch is pressed, it stops the power supply to the facing tool, the heating element, the hydraulic circuit (discharge of pressure, if applied), and the power supply socket. Power is further supplied to the micro-controller board (the display screen keeps working).



Important

When it was pressed, the Emergency Stop switch is locked. When the hazard is cleared, the switch has to be unlocked by turning the pushbutton clockwise. It is also possible to move the carriage of the basic machine chassis manually.

3.3 Connectors

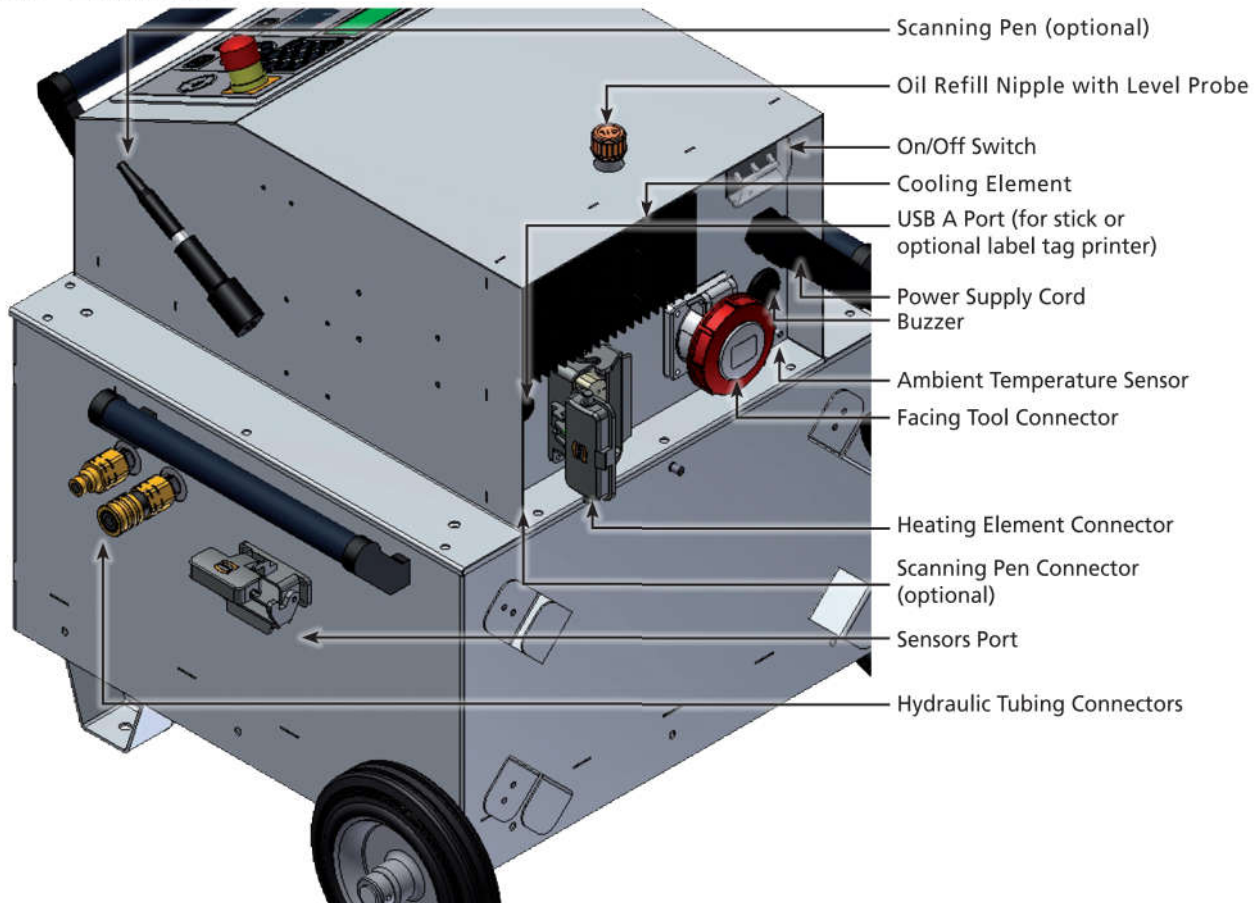

3.4 Technical Specifications

HÜRNER CNC ECO 1200	
Power Specifications	
Voltage	400 V 3 Ph * N
Frequency	50 Hz
Total Rated Power	22.20 kW
Heating Element	16.00 kW
Facing Tool	2.20 kW
Hydraulic & Control Unit	4.00 kW
Hydraulic Specifications	
Operating Pressure max.	250 bar
Cylinder	29.83 cm ²
Ambient Temperature Range	-5°C to +50°C
Hydraulic Oil	HF-E 15
Operating Range	630 through 1200 mm
Dimensions	
Basic Machine Chassis	2000 x 1720 x 1720 mm
Facing Tool	1300 x 1700 x 310 mm
Heating Element	1300 x 1620 x 100 mm
Hydraulic & Control Unit	680 x 690 x 680 mm
Weights	
Basic Machine Chassis	1050 kg
Facing Tool	345 kg
Heating Element	130 kg
Hydraulic & Control Unit	100 kg

3.5 Overview of the Welding Process

After the thermoplastic material, the pipe diameter, and the wall thickness were entered, the machine computes all parameters that are critical for the welding process, taking into account the selected welding standard (e.g., DVS, PIPA, NEN). The entire welding process is automatically controlled, monitored, and its data logged and saved to a welding report.

The saved welding data can subsequently be downloaded to a USB mass storage media as a short or extended report in the PDF format or the HÜRNER database format DataWork. Parameters applicable to the welded joint and traceability data on the processed parts can be entered either on the alphanumeric keypad on the front panel or read from a transponder chip card. Reading bar codes with a scanning pen or handheld scanner is available optionally.

For your convenience, the machine can be specifically customized in a Configuration Menu (see section 4.2).

The welder performs the welding process in the following manner:

- Pipes are clamped into the frame.
If pipes with an outside diameter smaller than the maximum dimension of the machine are welded, select the reducer set needed. The 8 individual inserts of the set that matches the outside diameter of the pipe to be welded have to be attached to the clamps of the machine chassis using the provided bolts.
- The mandatory and optional component traceability data and the data on the components are entered in the screen menus.
- Pipe butts are worked using the pipe facing tool.
- Pipe alignment is checked according to the information displayed on the screen.
- The technical data on the welding process itself are entered or reused from the preceding welding operation, provided the manual input of these data is enabled in the Configuration Menu.
- The heating element is inserted after cleaning it and checking its temperature.
- After the heating element was inserted, the pipes close in automatically on it at the predefined build-up pressure.
- During the build-up stage the weld bead builds up. When the bead size, as required under the selected standard, is achieved, the welder has to confirm successful bead build-up. (If Automode (see Section 4.2) is enabled, the successful bead build-up is detected automatically; the machine computes the build-up time depending on the parameters of the parts to be jointed.)
- The machine then moves on automatically to the heating stage.
- After the heating stage, the machine automatically moves the movable carriage apart and the welder has to remove the heating element from in-between the butts.
- After the removal of the heating element, the machine automatically closes the pipes in on each other.

- This is followed by a steady pressure increase until the joining pressure is reached.
- The new joint then cools down at the predefined pressure. If the selected welding standard requires the pressure to be reduced in the cooling stage, the machine performs this reduction automatically, in line with the provisions in the standard.
- After the cooling time is over, the machine shuts off the pressure automatically, and the joint can be taken out of the chassis.
- If the optional tag printer is used, a tag to label the new joint can be printed off.

4 Operation

4.1 Start of Operation, Switching the Machine on



Important

Before the control unit is turned on, check the oil level of the hydraulic and control unit and top up with HF-E 15 hydraulic oil as needed.



Important

The surfaces of the heating element have to be free of grease and clean, or they have to be cleaned.



Important

Make sure all connectors are tight in their sockets and note that operation on a worksite is only acceptable if the power supply has earth-leakage circuit breakers.

Place the machine on a level surface and ensure it cannot slide. After connecting the power supply cord to the mains power supply or a generator, the machine is turned on at the On/Off switch.



Caution

It has to be ensured that the voltage of the power source the machine is connected to corresponds to the rated voltage of the machine. Also the following has to be respected when using extension cables:

For 400 V power: wire section 4.0 mm² = max. 75 m long
 wire section 10.0 mm² = max. 100 m long

After the machine was switched on, first Display 1 appears on the screen, then a screen with the version of the used control software.

The machine will then automatically start an auto-test process (see Display 2); this test, which includes three screens, can be canceled by pressing the STOP/RESET key.



Important

If the input voltage is not within tolerance, from approx. 160 V to approx. 300 V, the machine switches itself off for protection. This protective feature is provided by a switch and will not result in an excess or insufficient voltage error line (see Sect. 4.6).

If the machine is not in the “open” position (i.e., movable carriage as far apart from the fixed one as possible), Display 3 shows. To move it, press the OPEN key. The machine will then move it to the far end.

After that, Display 4 shows, with the data of the next welding, including time of day, date, report number, and joint number, along with—in the second-to-last line—the actual input voltage and the actual and nominal heating element temperature before and after the slash.

```
*****
*           HÜRNER           *
*  CNC 1200 ECO 2.0  *
*****
```

Display 1

```
**  SYSTEM TEST  **
Remaining Prot. 1500
17:23           21.06.09
```

Display 2

```
Open carriage

208°C ACT.    0.5bar
```

Display 3

```
Next welding
15:44:52    29.05.12
235V       135C/220C
Rep. No. 00072/00002
```

Display 4

If the machine configuration requires the input of traceability data for the joint that is going to be welded (commission number, welder identification code, etc.), then input screens for these data are shown before Display 4 appears.

The joint number, or weld number, is based on the job/commission number. This means that it increments by 1 for every welding operation performed in the scope of the current commission (identified previously by entering the appropriate job number). In the example in Display 4, the next welding operation will be saved to welding report number 72 while the joint itself is joint number 2 of the current job/commission. For the joint number to be displayed, this option has to be enabled in the Configuration Menu.



The first joint of a commission for which no joint has been saved to memory so far, always receives no. 1. If the memory already holds joints for a commission, the machine finds the highest number of the joints existing for that commission and uses this number plus 1. The user is shown the number thus found on the screen and can apply or change it. If the user changes the joint number, it is his responsibility to make sure that no number is assigned twice in one commission. If a joint number appears twice in a commission, this will not affect the welding process and the logging of its data in any way. However, in that commission two joints will not be distinguished by a unique number.

If user inputs leave some joint numbers unused (for instance, for a given commission no. 1, 2, 3, 5, 6, 9), the gaps do not get filled, and the automatically found number proposed for the next welding operation will still be the highest existing number plus 1 (that is, 10 in this example).

The joint number can also be entered after simultaneously pressing the cursor keys \leftarrow and \rightarrow when Display 4 is showing on the screen.



After it was turned on, the machine generally is in its "open" position (see above). It is possible to bring the movable carriage to any desired position by pressing and holding down the INCREASE PRESSURE key. The carriage can then be sent back to the "open" position by pressing the OPEN key.



Depending on the software version installed in your machine, some screens may be slightly different on your display than the reproductions in this manual.

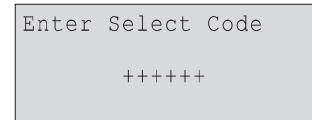

Display 5

CODE: 415311

4.2 Setting the Default Configuration of the Machine

The Configuration Menu is accessible by pressing the MENU key when Display 4 is showing on the screen.

When the operator presses the MENU key, the screen asks to enter a selection code (see Display 5). This is an access code that authorizes the operator to select and change the default configuration that determines how the machine behaves at every new welding operation. The selection code can be entered by typing it on the keypad or by reading it from a transponder card.

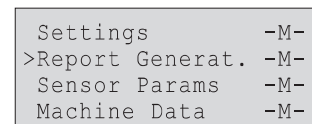

Display 6



Important

After entering an incorrect code three times, the machine returns to its "open" position (see Sect. 4.1 and Display 4). If the entered menu selections code is correct, the Configuration Menu shows on the screen, as in Display 6.

All screens of the Configuration Menu work in the same manner: use the \uparrow and \downarrow cursor keys to select a displayed configuration option. The option can then be set to ON or OFF using the \Rightarrow cursor key. The **-M-** displayed at some configuration options indicates that a further screen for that option can be accessed by pressing the MENU key.



Important

When you press the START/SET key, the displayed settings/ values are saved to memory and applied. Press the STOP/ RESET key to quit the currently displayed configuration screen without saving any modifications you may have made.

The "Sensor Parameters" and "Machine Data" menu options enable check and maintenance steps that are relevant only to technical service. They are therefore protected by a second access code and will not be addressed in this User's Manual.

The "Settings" sub-menu allows the definition of settings related to the machine itself and its operation during the welding process. In the "Report Generation" sub-menu, the design of the welding reports can be defined: which welding and traceability data to record, which kind of data logging.



Info

The alphanumeric keypad is designed and works like the keypad of a common mobile phone. If an input is numerical, the keypress generates the number found on the respective key. For an alphanumeric input, all characters found on a key can be generated by pressing that key repeatedly in a row. As soon as the desired character can be read on the screen, wait a little longer until you press the next key to use the displayed character.

In the "Settings" sub-menu of the Configuration Menu, the following parameters can be set:

Menu Item	Setting	Description / Possible Data
Automode	ON / OFF	if ON: the bead build-up stage is terminated automatically after a duration computed from the parameters of the parts to be welded, based on guideline values from experience (see also Sect. 4.5.5); if OFF: the bead build-up stage has to be terminated manually by pressing the START/SET key.
Memory Control	ON / OFF	if ON: when the system memory is full of reports, the system will be blocked until the reports are printed or downloaded; if OFF: it works but that the oldest report will be overwritten.
Ambient Temperature	ON / OFF	if ON: ambient temperature will be checked when machine is turned on; <i>If the outside temperature is below 0°C, no welding process should be started, or appropriate steps should be taken.</i> if OFF: no check of ambient temperature.
Manual Input	ON / OFF	if ON: it is possible to change the welding parameters manually; if OFF: manual change of welding parameters is impossible.
Automatic Heating Element	ON / OFF	if ON: if an automatically removing ("jumping") heating element is used, the system will remove it automatically from in-between the components during change-over; if OFF: no automatic removal is controlled by the system even when an automatically removing heating element is used; the welder will have to remove it manually at change-over.

Menu Item	Setting	Description / Possible Data
Check Code Expiry	ON / OFF	if ON: identification number/code of the welder who will perform the welding has to be current and not expired (default period of validity 2 years from code issuance), or the welding operation cannot be started; if OFF: number/code validity is not checked at all.
Angle	ON / OFF	if ON: prior to the facing process, the angle for the jointing of the components can be entered; if OFF: the input of an angle—hence, an elbowed joint—is impossible.
Welder Code Options	— M —	In a further screen, it can be determined when the welder code, if it is enabled at "Recording," has to be entered: always, i. e. before every single welding operation, only before the first welding operation after switching the unit on or only after the first welding operation of a new day/date.
Language	— M —	In a further screen, the language to use for the display screen and the printed reports can be selected.
Time/Date	— M —	In a further screen, the time and the date of the system clock can be set.
Buzzer Volume	— M —	In a further screen, the volume of the audible warning signal can be set.
Temperature Unit	— M —	In a further screen, the measurement unit used for temperature information can be set: Fahrenheit or Celsius.
Pressure Unit	— M —	In a further screen, the measurement unit used for pressure information can be set: bars or pounds per square inch.
Inventory Number	— M —	In a further screen, the number by which the machine/hydraulic unit used to perform the welding is identified in the inventory of the operating organization can be entered.
Number of Labels	— M —	In a further screen, the number of label tags to print out after a welding operation can be selected (requires the optionally available label tag printer).
Standard	— M —	In a further screen, the welding standard to be applied to the welding can be selected.

In the "Report Generation" sub-menu of the Configuration Menu, the following parameters can be set:

Menu Item	Setting	Description / Possible Data
Welder Code	ON / OFF	if ON: number/code of the welder who will perform the welding must be entered depending on the "Welder Code Always" value under "Settings" (see above); if OFF: the welder code is never requested by the machine.
Commission Number	ON / OFF	if ON: number/identifier of the commission to which the welding belongs must be entered before every welding; input of up to 32 alphanumeric characters.
Joint/Weld Number	ON / OFF	if ON: joint numbers related to a given job/commission can be assigned, and the machine automatically increments to joint numbers by 1 for that commission (see also at the end of Sect. 4.1). if OFF: the joint number management is not available.
Additional Data	ON / OFF	if ON: additional, user-defined data, e.g., address where the welding is performed, can be entered before every welding; input of up to 20 alphanumeric characters.
Fitting Code	ON / OFF	if ON: the code of a fitting to be welded, in which the parameters related to welding are contained, must be entered before welding.
Pipe Codes	ON / OFF	if ON: the code of the pipes, in which the pipe parameters related to welding are contained, must be entered before welding.

Menu Item	Setting	Description / Possible Data
Pipe Length	ON / OFF	if ON: the length of both pipes that are going to be welded has to be entered before the welding; if OFF: the length of the pipes cannot be entered.
Weather Conditions	ON / OFF	if ON: the weather conditions in which the welding takes place have to be selected in a list prior to welding; if OFF: the weather conditions will not be entered.
Installing Company	— M —	In a sub-menu, the name of the company carrying out the piping and installation work can be entered.
Print Tags	— M —	In a sub-menu, a completed welding operation can be selected to print off once more to label tag belonging to it.



All data that are available in the chip of a transponder card can be entered by placing the card in front of the card reader. Optionally, if they are encoded in a bar code, they can be read using a scanning pen or a handheld scanner.

4.3 Entering Traceability Data

If the machine is configured to request the input of traceability data related to the welding, such as commission number and welder identification code, then the screens for entering these data are shown before Display 4 appears (see Display 7). The same displays can be accessed through a list that opens after the ⇐ cursor key was pressed.

The input of these data uses either the alphanumeric keypad (see also the Info message in Section 4.2) and then they are confirmed by pressing the START/SET key, or they are read from a transponder card.

4.4 Entering Pipe or Fitting Parameters

From the “open” position of the machine (see Sect. 4.1 and Display 4), possibly after traceability data were entered, the parameters for the components to be jointed are shown (see Display 8), which can be confirmed or changed.

To confirm that the parameters on the display should be used for the next welding, press the START/SET key, to change them, press STOP/RESET to select the material of the parts to be welded (see Display 9) or the cursor key ↑ to enter the component diameter and wall thickness (see Display 10). To select a material use the ↑ and ↓ cursor keys and confirm your selection by pressing the START/SET key. The machine then moves on to pipe diameter/wall thickness input screen (see Display 10) as well.

It is possible to switch back and forth between the pipe material and the diameter/wall thickness screen without making any changes, by pressing the ↑ key.

The sub-menu that can be accessed at “Specialty Materials” allows the selection of non-standard materials, which frequently are proprietary, e.g., Wavin Safetech. As opposed to standard materials, specialties do not allow the selection of all nominal pipe diameters or SDR values, but only those that are actually available with that material. If a specialty material is selected, the diameter and the standard dimension ratio (SDR) have to be entered in all cases, as they will not be applied by the machine from the last completed welding operation.



The specialty material screens include a menu option “Standard Material” to enable returning to the screen in which they were selected, the screen reproduced in Display 9.

```
Enter Welder Code
+++++
+++++
```

Display 7

```
PE-HD
Pipe Diameter:0250mm
Wallthickness:22.7mm
ESC SDR 11.0 ENTER
```

Display 8

```
SELECT PIPE MATERIAL
>PE80
PP
Specialty Mater.-M-
```

Display 9

```
ENTER PIPE DIMENSION

Pipe Diameter:0250mm
Wallthickness:22.7mm
```

Display 10

In the screen for the diameter and the wall thickness of the pipes to be jointed (see Display 10), the welder has to enter these data. Using the entered data on material, diameter, and wall thickness or SDR ratio of the parts, the machine computes the required pressures, welding stage durations, and the heating element temperature.



It is possible to switch back and forth between the wall thickness and SDR value lines with the \downarrow key (see Display 11).

When all data were entered, the parameters, along with the computed SDR value or wall thickness, are displayed again for verification (see Display 12). Any other change, if needed, can be started from here.

Confirm these values by pressing START/SET in order to go on to the welding process proper.

```
ENTER PIPE DIMENSION
Pipe Diameter:0250mm
SDR           :11.0
```

Display 11

```
PE-HD
Pipe Diameter:0250mm
Wallthickness:22.7mm
ESC   SDR 11.0 ENTER
```

Display 12

4.5 Performing the Welding Process

To start welding, clamp the pipes into the machine chassis. Use the appropriate reducers if the component size is smaller than the basic machine chassis. When the third clamp of the machine is fastened to its movable carriage, to move with the first and second pipe clamp, tees and elbows can be clamped for processing into the fourth pipe clamp of the machine. Then, to launch the welding process, press the START/SET key.

When the welding parameters were confirmed or entered, pipe facing starts.

4.5.1 Facing the Pipe Butts

To ensure that the pipe butts are level, insert the pipe facing tool between the machine carriages and turn it on. The machine then closes the movable carriage in automatically in order to bring the pipes into contact with the facing tool. Use the INCREASE PRESSURE and REDUCE PRESSURE keys to adjust the pressure manually while the facing tool is trimming the pipes.

Pipe facing should continue until shaving forms a continuous blade that rolls twice or three times around the pipe ends, so the butts are level. To stop facing, press the START/SET key. The machine then moves the movable carriage apart.

If you discover after the facing process that the butts are still not level, start over, insert the facing tool and repeat the process. It starts again automatically. When facing is properly done, pipe alignment has to be checked (see Display 14).

```
Face Pipe Ends
230°C ACT.   0.5bar
```

Display 13

```
Check Pipe Alignment
Max. Gap       :2.5mm
```

Display 14

4.5.2 Checking Pipe Alignment

When the pipes are properly faced, close in the movable carriage completely by pressing the START/SET key, in order to check whether a potential vertical and horizontal pipe misalignment is within the tolerance allowed by the applicable welding standard. The maximum acceptable gap between them is displayed (see Display 14). If the misalignment is outside tolerance, the pipes must be readjusted in the clamps and, if needed, facing has to be repeated. To repeat facing, press the OPEN key, which will set the movable carriage back to the far end.

When pipe alignment is appropriate, move the carriage apart to the far end for the welding proper, by pressing the START/SET key. If needed, the welding process can be aborted by pressing the STOP/RESET key.

4.5.3 Possibility to Change Welding Parameters

Subsequent to facing the pipe butts and checking the alignment of the parts to be welded, Display 15 shows on the screen, provided that manual data input is enabled in the Configuration Menu. In Display 15, the welder can keep the parameters that define the welding process, from the last welding by pressing the START/SET key, if there are such parameters in memory already, or he can adjust them to the welding at hand by pressing the STOP/RESET key (see Display 16).

```
Do you want to use
data of previous
welding?
ESC                <J
```

Display 15

The screens enabling manual input of welding parameters (Displays 16 and 17 plus one more line, not shown, for the heating element temperature) allow the selection of a line using the \uparrow and \downarrow cursor keys. After selecting a line, its parameter value is changed by typing the desired value on the alphanumeric keypad. The START/SET key serves to confirm the inputs; then the control unit moves on from display to display or from the last to the welding process.

```
Buildup pr.:030.5bar
Heatsoakpr.:010.5bar
Heatsoaking:0120 s
Change-over:0005 s
```

Display 16



Info

The parameters set manually are kept in memory when the machine is turned off. If the pipe parameters change, **all** parameters have to be set once again. The machine recognizes the changed pipe parameters and brings the operator directly to the menu that allows changing them.

```
Cool. time t5:100 s
Cool. time t6:800 s
Cool. Pres.t6:012.2b
Press. ramp:010 s
```

Display 17

4.5.4 Inserting and Monitoring the Heating Element

The machine controls and monitors constantly the temperature of the heating element. If the temperature is not within the tolerance thresholds, the machine shows an error message to this effect in the first line of the display. Furthermore, the upper and lower thresholds of the tolerance range are indicated in the fourth line along with the current actual temperature (see Display 18).

```
Plate temp. too low

222°C < 210°C < 232°C
```

Display 18

As soon as the nominal temperature is reached, Display 19 shows.

By inserting the heating element and pressing the START/SET key, you make the machine move on to the bead build-up stage. At this time, the pipes are placed together automatically and the computed pressure during bead build-up is applied.

```
Put in heat. plate

222°C  nom.  16.5bar
221°C  act.   0.5bar
```

Display 19

4.5.5 Bead Build-up Stage

During the bead build-up stage, LED 1 flashes to indicate the progress of the welding process. As soon as the build-up pressure is reached, as shown in Display 20, both the computed maximum bead size and the bead build-up time. If Automode is enabled the time is a countdown of the remaining bead build-up time; if it is off, the time value increases and shows the duration already used. During this stage, the build-up pressure and the heating element temperature are monitored.

```
Bead Height      :2.0mm
Bead Build Time:68 s
230°C  NOM.  16.5bar
229°C  ACT.  12.5bar
```

Display 20

When the bead reaches the size indicated on the display, the operator has to press the START/SET key to terminate the build-up stage, unless the Automode (see below) is used. The machine then moves on to the heating, or heat-soaking, stage.

As long as the nominal pressure of the heating stage is not reached yet, LED 2 flashes while LED 1 is lit. The machine reduces pressure automatically.



Info

The so-called automode is a tool for monitoring the duration of the bead build-up stage and moving on automatically from the bead build-up to the heating stage by decreasing the applied pressure. However, this

requires that the automode was enabled in the Configuration Menu. If the welder sees that the bead has fully formed although the bead build-up countdown has not completed ended, he can end the bead build-up stage early by pressing the START/SET key. The responsibility for the proper joint of the components resides with the welder entirely.



Important

Prior to the bead build-up of a welding process for which the Automode can be used, the machine asks whether the bead build-up time of the previous welding operation should be re-used. Confirm this only if the ambient conditions, too, (temperature, weather/rain tent etc.) are sufficiently similar. If the application of the automode build-up time is denied, the operator will have to confirm successful bead build-up manually.



Important

If the welding parameters of the welding operation were entered manually, the Automode is always disabled.

4.5.6 Heating Stage

The time for soaking heat in the heating stage is displayed as a countdown showing the remaining seconds (see Display 21). A signal is audible during the final 10 seconds of heat soaking, right before the change-over stage. During the heating stage LED 3 flashes; LED 1 and LED 2 are lit.

HEAT SOAK PHASE		
Heat Soak Time	:	148s
230°C	MAX	5.0bar
229°C	ACT.	3.5bar

Display 21

During this stage, the pressure applied while the pipes soak heat, and the heating element temperature are monitored and controlled.

4.5.7 Change-over Stage

After the full heating time, the carriage moves apart automatically. The heating element has to be removed as fast as possible (see Display 22). On machines equipped with an optional automatic heating element, it retracts automatically from in-between the pipes. During the change-over stage LED 4 flashes; all previous LEDs are lit.

Remove plate		
Change-over	:	8 s
230°C	MAX	5.0bar
229°C	ACT.	3.5bar

Display 22

The machine then presses the pipes automatically together again.

4.5.8 Joining and Cooling Stage

In the joining stage the machine increases pressure in accordance with the pressure ramp computed for the joint (see Display 23). During this stage LED 5 flashes; all previous LEDs are lit.

JOINING PHASE		
230°C	NOM.	16.5bar
229°C	ACT.	14.5bar

Display 23

When the full joining pressure is reached, the machine moves on to the cooling stage (see Display 24). The cooling-down is represented as a countdown of the remaining duration. During cooling, the joining pressure applied in this stage is monitored. In the process, LED 6 flashes, all the previous LEDs are lit.

COOLING PHASE		
Cooling time	:	1234s
230°C	NOM.	16.5bar
229°C	ACT.	16.5bar

Display 24



Info

Some standard, e.g., DVS, require the joining pressure to be the same throughout cooling (t_5). Others have it that the initial joining pressure (t_5) must be reduced after some time into cooling (t_6). If such a standard was selected, the machine takes care of the pressure reduction required by the standard. In that stage LED 7 flashes, all the other LEDs are lit.

COOLING PHASE		
Cooling time over		
229°C	ACT.	0.0bar

Display 25

4.5.9 End of Welding

A beep signals the end of the cooling time. Furthermore, the green LED is lit to indicate a successful welding process. Confirm the end of

welding by pressing the START/SET key. Pressure to the hydraulic lines will then be shut off.

4.5.10 Printing Label Tags

If the optional tag printer is connected to the USB port, tags used to label the new joint can be printed from Display 25 after the welding. To do so, press the START/SET key, and printing starts. The number of tags is defined in the appropriate setting of the Configuration Menu, under "Settings." The screen indicates the end of printing. If printing is impossible, the appropriate error message shows on the screen.

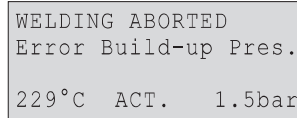

Display 26

4.6 Displaying Characteristics of the Welding System

The key technical information on the welding system itself is displayed by pressing the ⇒ key at the "Next Welding" screen (Display 4). They are the software version, the serial number of the system, and the number of currently available, unused reports. To quit this screen, press the STOP/RESET key.

4.7 Using ViewWeld to Manage Logged Welding Reports and Print Tags

The ViewWeld feature offers viewing an abstracted version of the welding reports recorded during the welding processes and printing it as a label tag to be affixed to the joint on the optionally available tag printer. The ViewWeld abstract shows the report number, the date and time of the welding and the welding parameters along with an evaluation of the quality of the joint/welding operation (see Display 27), where the first displayed abstract is that of the last performed welding operation.

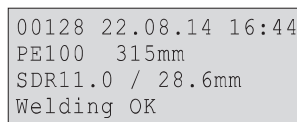

Display 27

To call the ViewWeld abstract of a welding report, press the ↑ key in the Next Welding screen (see Display 4). Browsing through the saved welding reports is then possible by pressing the ⇐ or ⇒ cursor keys. To print a tag of the welding operation of which the abstract is currently displayed, the label tag printer has to be connected to the welder. Then press the START/SET key in the ViewWeld screen.

4.8 Aborted Welding Process

All parameters relevant to the welding are constantly monitored while the welding process is running. If one or more of the parameters are out of tolerance and the machine cannot adjust them within a specified delay, the welding process is aborted.

The error that made the welding abort is displayed on the screen (see Display 26). Additionally, in the welding diagram the LED that belongs to the welding stage with the malfunction starts flashing.

The errors listed in the following table can be displayed on the screen.

Type of Error	Description
a. Data Input	
Input Error	Error while entering data on the keypad.
Code Error	Error while reading data from a transponder card.
b. System	
Clock Error	The internal clock of the machine is defective; re-set the clock in the Configuration Menu.

Type of Error	Description
System Error	Malfunction in the control system of the machine; power to the machine has to be turned off and disconnected immediately, and the machine has to be sent to the manufacturer or an authorized service point for check and repair.
Pressure Sensor Defective	The sensor indicated on the display (hydraulic pressure, heating element temperature, ambient temperature) is defective; where possible, check the connections/plug; have the machine inspected by an authorized service shop if needed.
Heating Sensor Defective	
Temperature Sensor Defective	
Printer not Ready (only label tag printer)	The optional printer connected to the machine is not ready (possible reasons: no communication or faulty cable).
c. Welding Process	
Temperature low	Heating element temperature will be increased automatically.
Temperature high	Heating element temperature will be reduced automatically.
Insufficient Voltage	The input voltage to the hydraulic and control unit is < 185V; the welding process is likely flawed, and repeating it is recommended.
Excessive Voltage	The input voltage to the hydraulic and control unit is > 280V; the welding process is likely flawed, and repeating it is recommended.
Error Changeover	It took too long to retract the heating plate and bring the pipes to joining; welding will have to be repeated.
Ambient Temperature high	Outside temperature outside the range from -5°C to +50°C.
Ambient Temperature low	Outside temperature outside the range from -5°C to +50°C.
Error Drag Pressure	Impossible to determine the drag pressure (pressure to "drag" the pipes along by setting the movable carriage in motion); maybe pipes will have to be clamped once again.
Error Build-up Pressure	Computed maximum pressure that will be applied during welding is too high; impossible to start welding; maybe pipes will have to be clamped once again.
Error Heating Pressure	Heat-soaking pressure too high, could not be re-adjusted.
Error Joining Pressure	Joining pressure too high or too low, could not be re-adjusted.
Hydraulics Overheating	The temperature of the hydraulic unit is too high. The next welding may result in overheating of the unit, which is why the welding operation is possible only after a period of letting the hydraulic unit cool.
Cooling Stopped	Operator has stopped the cooling time by pressing the STOP/RESET key.
Power Supply Failure	In the course of the last welding a power supply failure occurred; welding has to be repeated. <i>This error occurs only when the machine is switched on after the welding operation during which the supply failure happened. It then has to be reacted to by pressing the STOP/RESET key.</i>
Hydraulic too Hot	The temperature of the hydraulic and control unit is > 100°C and it has switches itself off; the welding process must be repeated.
Error Plate Temperature	Heating element temperature is out of tolerance; impossible to re-adjust the temperature; if no heating element failure can be found, maybe the ambient temperature was too low.
Emergency Stop	The welder has switched the machine off using the Emergency Stop switch. If this was done because of a malfunction of the machine, it must not be turned on again, unless it is beyond doubt that it works properly.

5 Downloading Welding Reports

The product is equipped with a USB interface for connecting a USB mass storage media (such as a USB stick).

The interface complies with the USB version 2.0 specification (i.e., maximum data rate of 480 megabits per second) for FAT 32.

5.1 Selecting the Reports to Download

When a storage media is connected, the machine displays the options menu. These options enable selecting which welding reports will be sent to the storage media as short reports, extended reports, both in the PDF format, or in the DataWork database format.

```
Select File Format
>DataWork File
  PDF Short Report
  PDF Long Report
```

Display 28

Using the \uparrow and \downarrow cursor keys, select what to send. First define the format of the file (Display 28) and confirm the selection by pressing the START/SET key. The "Service Report" also appearing in this menu is a log of the last maintenance protocol that the product underwent. In the next screen, select the scope of the download: all reports currently in memory, all reports belonging to a given commission, all report within a range of dates or all reports from one report number to another report number (Display 29).

```
** PRINT OPTIONS **
>Print All Reports
  By Commission No.
  Date Range
```

Display 29

All options, excepting "All Reports," require the operator to enter, in the next screen, the corresponding restriction of reports to download, e.g., (see Display 30) the number of the commission of which the reports should be downloaded. Where applicable, this input has to be confirmed by the START/SET key.

```
Commission No.
+++++
+++++
```

Display 30

5.2 Saving the Reports to a Storage Media

The report download starts automatically after a selection was made in the options menu. Wait for all the selected reports to download and the "Finished" message to appear on the screen.

If a problem occurs while the download is in progress, the transmission is suspended. After the problem condition is cleared, the download resumes automatically.



If the product recognizes a problem that cannot be cleared while data transfer is in progress, it does not resume the transfer and displays an "Interrupted" error message.

5.3 Deleting Data in Memory

The report data in memory can be deleted only if all welding reports were already downloaded. When the download is finished, a "Finished" message indicates this. At this point, unplugging the storage media or pressing the START/SET key displays a "Delete Memory" message. When the START/SET key is pressed here, a further confirmation message "Delete Memory, sure?" is shown, which has to be confirmed by pressing the START/SET key once again. Then, the report data in memory is deleted.



Important

For every data download, always be sure to wait until the display shows the "Finished" message before you disconnect the cable or media from the welding system. If you disconnect it too early, the welding system may ask you whether you want to delete the data in memory, although the reports were not properly downloaded. Then if you delete the contents of the data logging memory, the reports would be irrevocably lost and would not have been saved elsewhere.

5.4 Keeping Data in Memory

When the storage media is unplugged, a "Delete Memory" message is displayed. Press the STOP/RESEZ key to keep the current report data in memory. They can then be downloaded once again.

6 Service and Repair

As the product is used in applications sensitive to safety considerations, it may be serviced and repaired only on our premises or by partners who were specifically trained and authorized by us. Thus, constantly high standards of operation quality and safety are maintained.



Non-compliance with this provision will dispense the manufacturer from any warranty and liability claims for the product and any consequential damage.

Important

7 Service and Repair Contact

HÜRNER Schweißtechnik
Nieder-Ohmener Str. 26
35325 Mücke, Germany

Tel.: +49 (0)6401 9127 0
Fax: +49 (0)6401 9127 39

Web: www.huerner.de

E-mail: info@huerner.de



Info

We reserve the right to change technical specifications of the product without prior notice.

A risk assessment under the provisions of the so-called machinery directive 2006/42/EC was conducted for the machine by a qualified person entitled to the performance of such an assessment.

Pursuant to the directive 2002/96/EC on Waste Electrical and Electronic Equipment (so-called WEEE Directive), equipment that was manufactured or distributed by ourselves may be returned to us. To discuss the exact procedure we will follow, please contact us with the details above.

We also declare that the equipment manufacture conforms to the directive 2011/65/EU on the restriction of the use of certain hazardous substances in electrical and electronic equipment (so-called RoHS Directive).

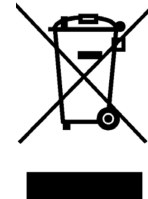

8 Accessories/Parts for the Product

Facing Tool Blade for HÜRNER CNC ECO 1200



Info

Only genuine spare parts are acceptable. The use of non-genuine parts voids any and all liability and warranty on the part of the manufacturer.

For consultation and ordering spare parts, refer to the seller or manufacturer of the product.